



Programmable Controller

MELSEC iQ-R
series

MELSEC iQ-R CC-Link System
Master/Local Module User's Manual
(Startup)

-RJ61BT11



SAFETY PRECAUTIONS

(Read these precautions before using this product.)

Before using this product, please read this manual and the relevant manuals carefully and pay full attention to safety to handle the product correctly.

The precautions given in this manual are concerned with this product only. For the safety precautions of the programmable controller system, refer to the user's manual for the CPU module used.

In this manual, the safety precautions are classified into two levels: "⚠️ WARNING" and "⚠️ CAUTION".

 WARNING	Indicates that incorrect handling may cause hazardous conditions, resulting in death or severe injury.
 CAUTION	Indicates that incorrect handling may cause hazardous conditions, resulting in minor or moderate injury or property damage.

Under some circumstances, failure to observe the precautions given under "⚠️ CAUTION" may lead to serious consequences.

Observe the precautions of both levels because they are important for personal and system safety.

Make sure that the end users read this manual and then keep the manual in a safe place for future reference.

[Design Precautions]

WARNING

- Configure safety circuits external to the programmable controller to ensure that the entire system operates safely even when a fault occurs in the external power supply or the programmable controller. Failure to do so may result in an accident due to an incorrect output or malfunction.
 - (1) Emergency stop circuits, protection circuits, and protective interlock circuits for conflicting operations (such as forward/reverse rotations or upper/lower limit positioning) must be configured external to the programmable controller.
 - (2) When the programmable controller detects an abnormal condition, it stops the operation and all outputs are:
 - Turned off if the overcurrent or overvoltage protection of the power supply module is activated.
 - Held or turned off according to the parameter setting if the self-diagnostic function of the CPU module detects an error such as a watchdog timer error.
 - (3) All outputs may be turned on if an error occurs in a part, such as an I/O control part, where the CPU module cannot detect any error. To ensure safety operation in such a case, provide a safety mechanism or a fail-safe circuit external to the programmable controller. For a fail-safe circuit example, refer to "General Safety Requirements" in the MELSEC iQ-R Module Configuration Manual.
 - (4) Outputs may remain on or off due to a failure of a component such as a relay and transistor in an output circuit. Configure an external circuit for monitoring output signals that could cause a serious accident.
 - In an output circuit, when a load current exceeding the rated current or an overcurrent caused by a load short-circuit flows for a long time, it may cause smoke and fire. To prevent this, configure an external safety circuit, such as a fuse.
 - Configure a circuit so that the programmable controller is turned on first and then the external power supply. If the external power supply is turned on first, an accident may occur due to an incorrect output or malfunction.
 - For the operating status of each station after a communication failure, refer to manuals relevant to the network. Incorrect output or malfunction due to a communication failure may result in an accident.
-

[Design Precautions]

WARNING

- When connecting an external device with a CPU module or intelligent function module to modify data of a running programmable controller, configure an interlock circuit in the program to ensure that the entire system will always operate safely. For other forms of control (such as program modification, parameter change, forced output, or operating status change) of a running programmable controller, read the relevant manuals carefully and ensure that the operation is safe before proceeding. Improper operation may damage machines or cause accidents.
 - Especially, when a remote programmable controller is controlled by an external device, immediate action cannot be taken if a problem occurs in the programmable controller due to a communication failure. To prevent this, configure an interlock circuit in the program, and determine corrective actions to be taken between the external device and CPU module in case of a communication failure.
 - Do not write any data to the "system area" and "write-protect area" of the buffer memory in the module. Also, do not use any "use prohibited" signals as an output signal from the CPU module to each module. Doing so may cause malfunction of the programmable controller system. For the "system area", "write-protect area", and the "use prohibited" signals, refer to the user's manual for the module used.
 - If a communication cable is disconnected, the network may be unstable, resulting in a communication failure of multiple stations. Configure an interlock circuit in the program to ensure that the entire system will always operate safely even if communications fail. Failure to do so may result in an accident due to an incorrect output or malfunction.
 - To maintain the safety of the programmable controller system against unauthorized access from external devices via the network, take appropriate measures. To maintain the safety against unauthorized access via the Internet, take measures such as installing a firewall.
-

[Design Precautions]

CAUTION

- Do not install the control lines or communication cables together with the main circuit lines or power cables. Keep a distance of 100mm or more between them. Failure to do so may result in malfunction due to noise.
 - During control of an inductive load such as a lamp, heater, or solenoid valve, a large current (approximately ten times greater than normal) may flow when the output is turned from off to on. Therefore, use a module that has a sufficient current rating.
 - After the CPU module is powered on or is reset, the time taken to enter the RUN status varies depending on the system configuration, parameter settings, and/or program size. Design circuits so that the entire system will always operate safely, regardless of the time.
 - Do not power off the programmable controller or reset the CPU module while the settings are being written. Doing so will make the data in the flash ROM and SD memory card undefined. The values need to be set in the buffer memory and written to the flash ROM and SD memory card again. Doing so also may cause malfunction or failure of the module.
 - When changing the operating status of the CPU module from external devices (such as the remote RUN/STOP functions), select "Do Not OPEN in Program" for "Open Method Setting" of "Module Parameter". If "OPEN in Program" is selected, an execution of the remote STOP function causes the communication line to close. Consequently, the CPU module cannot reopen the line, and external devices cannot execute the remote RUN function.
-

[Installation Precautions]

WARNING

- Shut off the external power supply (all phases) used in the system before mounting or removing the module. Failure to do so may result in electric shock or cause the module to fail or malfunction.
-

[Installation Precautions]

CAUTION

- Use the programmable controller in an environment that meets the general specifications in the Safety Guidelines included with the base unit. Failure to do so may result in electric shock, fire, malfunction, or damage to or deterioration of the product.
 - To mount a module, place the concave part(s) located at the bottom onto the guide(s) of the base unit, and push in the module until the hook(s) located at the top snaps into place. Incorrect interconnection may cause malfunction, failure, or drop of the module.
 - To mount a module with no module fixing hook, place the concave part(s) located at the bottom onto the guide(s) of the base unit, push in the module, and fix it with screw(s). Incorrect interconnection may cause malfunction, failure, or drop of the module.
 - When using the programmable controller in an environment of frequent vibrations, fix the module with a screw.
 - Tighten the screws within the specified torque range. Undertightening can cause drop of the screw, short circuit, or malfunction. Overtightening can damage the screw and/or module, resulting in drop, short circuit, or malfunction.
 - When using an extension cable, connect it to the extension cable connector of the base unit securely. Check the connection for looseness. Poor contact may cause malfunction.
 - When using an SD memory card, fully insert it into the SD memory card slot. Check that it is inserted completely. Poor contact may cause malfunction.
 - Securely insert an extended SRAM cassette or battery-less option cassette into the cassette connector of the CPU module. After insertion, close the cassette cover and check that the cassette is inserted completely. Poor contact may cause malfunction.
 - Do not directly touch any conductive parts and electronic components of the module, SD memory card, extended SRAM cassette, connector, or battery-less option cassette. Doing so can cause malfunction or failure of the module.
-

[Wiring Precautions]

WARNING

- Shut off the external power supply (all phases) used in the system before installation and wiring. Failure to do so may result in electric shock or cause the module to fail or malfunction.
 - After installation and wiring, attach a blank cover module (RG60) to each empty slot and an included extension connector protective cover to the unused extension cable connector before powering on the system for operation. Failure to do so may result in electric shock.
-

[Wiring Precautions]

CAUTION

- Individually ground the FG and LG terminals of the programmable controller with a ground resistance of 100 ohms or less. Failure to do so may result in electric shock or malfunction.
 - Use a solderless terminal with an insulation sleeve for terminal block wiring. Note that up to two solderless terminals can be connected per terminal block.
 - Use applicable solderless terminals and tighten them within the specified torque range. If any spade solderless terminal is used, it may be disconnected when the terminal screw comes loose, resulting in failure.
 - Check the rated voltage and signal layout before wiring to the module, and connect the cables correctly. Connecting a power supply with a different voltage rating or incorrect wiring may cause fire or failure.
 - Connectors for external devices must be crimped or pressed with the tool specified by the manufacturer, or must be correctly soldered. Incomplete connections may cause short circuit, fire, or malfunction.
 - Securely connect the connector to the module. Poor contact may cause malfunction.
 - Do not install the control lines or communication cables together with the main circuit lines or power cables. Keep a distance of 100mm or more between them. Failure to do so may result in malfunction due to noise.
 - When an overcurrent caused by an error of an external device or a failure of a module flows for a long time, it may cause smoke and fire. To prevent this, configure an external safety circuit, such as a fuse.
 - Place the cables in a duct or clamp them. If not, dangling cable may swing or inadvertently be pulled, resulting in damage to the module or cables or malfunction due to poor contact. Do not clamp the extension cables with the jacket stripped. Doing so may change the characteristics of the cables, resulting in malfunction.
 - When disconnecting the communication cable or power cable from the module, do not pull the cable by the cable part. For the cable connected to the terminal block, loosen the terminal screws. Pulling the cable connected to the module may result in malfunction or damage to the module or cable.
 - Check the interface type and correctly connect the cable. Incorrect wiring (connecting the cable to an incorrect interface) may cause failure of the module and external device.
 - Tighten the terminal screws or connector screws within the specified torque range. Undertightening can cause drop of the screw, short circuit, fire, or malfunction. Overtightening can damage the screw and/or module, resulting in drop, short circuit, fire, or malfunction.
 - Tighten the terminal block mounting screws, terminal screws, and module fixing screws within each specified torque range. Undertightening of the terminal block mounting screws and terminal screws can cause short circuit, fire, or malfunction. Overtightening of them can damage the screw and/or module, resulting in drop, short circuit, or malfunction. Undertightening of the module fixing screws can cause drop of the screw. Overtightening of them can damage the screw and/or module, resulting in drop.
 - Prevent foreign matter such as dust or wire chips from entering the module. Such foreign matter can cause a fire, failure, or malfunction.
 - A protective film is attached to the top of the module to prevent foreign matter, such as wire chips, from entering the module during wiring. Do not remove the film during wiring. Remove it for heat dissipation before system operation.
-

[Wiring Precautions]

CAUTION

- Programmable controllers must be installed in control panels. Connect the main power supply to the power supply module in the control panel through a relay terminal block. Wiring and replacement of a power supply module must be performed by qualified maintenance personnel with knowledge of protection against electric shock. For wiring, refer to the MELSEC iQ-R Module Configuration Manual.
 - For Ethernet cables to be used in the system, select the ones that meet the specifications in the user's manual for the module used. If not, normal data transmission is not guaranteed.
 - Use Ver.1.10-compatible CC-Link dedicated cables in a CC-Link system.
If not, the performance of the CC-Link system is not guaranteed.
For maximum overall cable length and station-to-station cable length, select the one that meet the specifications in this manual. If not, normal data transmission is not guaranteed.
-

[Startup and Maintenance Precautions]

WARNING

- Do not touch any terminal while power is on. Doing so will cause electric shock or malfunction.
 - Correctly connect the battery connector. Do not charge, disassemble, heat, short-circuit, solder, or throw the battery into the fire. Also, do not expose it to liquid or strong shock. Doing so will cause the battery to produce heat, explode, ignite, or leak, resulting in injury and fire.
 - Shut off the external power supply (all phases) used in the system before cleaning the module or retightening the terminal screws, connector screws, or module fixing screws. Failure to do so may result in electric shock.
-

[Startup and Maintenance Precautions]

CAUTION

- When connecting an external device with a CPU module or intelligent function module to modify data of a running programmable controller, configure an interlock circuit in the program to ensure that the entire system will always operate safely. For other forms of control (such as program modification, parameter change, forced output, or operating status change) of a running programmable controller, read the relevant manuals carefully and ensure that the operation is safe before proceeding. Improper operation may damage machines or cause accidents.
 - Especially, when a remote programmable controller is controlled by an external device, immediate action cannot be taken if a problem occurs in the programmable controller due to a communication failure. To prevent this, configure an interlock circuit in the program, and determine corrective actions to be taken between the external device and CPU module in case of a communication failure.
 - Do not disassemble or modify the modules. Doing so may cause failure, malfunction, injury, or a fire.
 - Use any radio communication device such as a cellular phone or PHS (Personal Handy-phone System) more than 25cm away in all directions from the programmable controller. Failure to do so may cause malfunction.
 - Shut off the external power supply (all phases) used in the system before mounting or removing the module. Failure to do so may cause the module to fail or malfunction.
 - Tighten the screws within the specified torque range. Undertightening can cause drop of the component or wire, short circuit, or malfunction. Overtightening can damage the screw and/or module, resulting in drop, short circuit, or malfunction.
 - After the first use of the product, do not mount/remove the module to/from the base unit, and the terminal block to/from the module, and do not insert/remove the extended SRAM cassette or battery-less option cassette to/from the CPU module more than 50 times (IEC 61131-2 and JIS B 3502 compliant) respectively. Exceeding the limit may cause malfunction.
 - After the first use of the product, do not insert/remove the SD memory card to/from the CPU module more than 500 times. Exceeding the limit may cause malfunction.
 - Do not touch the metal terminals on the back side of the SD memory card. Doing so may cause malfunction or failure.
 - Do not touch the integrated circuits on the circuit board of an extended SRAM cassette or battery-less option cassette. Doing so may cause malfunction or failure of the module.
 - Do not drop or apply shock to the battery to be installed in the module. Doing so may damage the battery, causing the battery fluid to leak inside the battery. If the battery is dropped or any shock is applied to it, dispose of it without using.
 - Startup and maintenance of a control panel must be performed by qualified maintenance personnel with knowledge of protection against electric shock. Lock the control panel so that only qualified maintenance personnel can operate it.
 - Before handling the module, touch a conducting object such as a grounded metal to discharge the static electricity from the human body. Failure to do so may cause the module to fail or malfunction.
-

[Operating Precautions]

CAUTION

- When changing data and operating status, and modifying program of the running programmable controller from an external device such as a personal computer connected to an intelligent function module, read relevant manuals carefully and ensure the safety before operation. Incorrect change or modification may cause system malfunction, damage to the machines, or accidents.
 - Do not power off the programmable controller or reset the CPU module while the setting values in the buffer memory are being written to the flash ROM in the module. Doing so will make the data in the flash ROM and SD memory card undefined. The values need to be set in the buffer memory and written to the flash ROM and SD memory card again. Doing so can cause malfunction or failure of the module.
-

[Disposal Precautions]

CAUTION

- When disposing of this product, treat it as industrial waste.
 - When disposing of batteries, separate them from other wastes according to the local regulations. For details on battery regulations in EU member states, refer to the MELSEC iQ-R Module Configuration Manual.
-

[Transportation Precautions]

CAUTION

- When transporting lithium batteries, follow the transportation regulations. For details on the regulated models, refer to the MELSEC iQ-R Module Configuration Manual.
 - The halogens (such as fluorine, chlorine, bromine, and iodine), which are contained in a fumigant used for disinfection and pest control of wood packaging materials, may cause failure of the product. Prevent the entry of fumigant residues into the product or consider other methods (such as heat treatment) instead of fumigation. The disinfection and pest control measures must be applied to unprocessed raw wood.
-

CONDITIONS OF USE FOR THE PRODUCT

(1) Mitsubishi programmable controller ("the PRODUCT") shall be used in conditions;

- i) where any problem, fault or failure occurring in the PRODUCT, if any, shall not lead to any major or serious accident; and
- ii) where the backup and fail-safe function are systematically or automatically provided outside of the PRODUCT for the case of any problem, fault or failure occurring in the PRODUCT.

(2) The PRODUCT has been designed and manufactured for the purpose of being used in general industries.

MITSUBISHI SHALL HAVE NO RESPONSIBILITY OR LIABILITY (INCLUDING, BUT NOT LIMITED TO ANY AND ALL RESPONSIBILITY OR LIABILITY BASED ON CONTRACT, WARRANTY, TORT, PRODUCT LIABILITY) FOR ANY INJURY OR DEATH TO PERSONS OR LOSS OR DAMAGE TO PROPERTY CAUSED BY the PRODUCT THAT ARE OPERATED OR USED IN APPLICATION NOT INTENDED OR EXCLUDED BY INSTRUCTIONS, PRECAUTIONS, OR WARNING CONTAINED IN MITSUBISHI'S USER, INSTRUCTION AND/OR SAFETY MANUALS, TECHNICAL BULLETINS AND GUIDELINES FOR the PRODUCT.

("Prohibited Application")

Prohibited Applications include, but not limited to, the use of the PRODUCT in;

- Nuclear Power Plants and any other power plants operated by Power companies, and/or any other cases in which the public could be affected if any problem or fault occurs in the PRODUCT.
- Railway companies or Public service purposes, and/or any other cases in which establishment of a special quality assurance system is required by the Purchaser or End User.
- Aircraft or Aerospace, Medical applications, Train equipment, transport equipment such as Elevator and Escalator, Incineration and Fuel devices, Vehicles, Manned transportation, Equipment for Recreation and Amusement, and Safety devices, handling of Nuclear or Hazardous Materials or Chemicals, Mining and Drilling, and/or other applications where there is a significant risk of injury to the public or property.

Notwithstanding the above, restrictions Mitsubishi may in its sole discretion, authorize use of the PRODUCT in one or more of the Prohibited Applications, provided that the usage of the PRODUCT is limited only for the specific applications agreed to by Mitsubishi and provided further that no special quality assurance or fail-safe, redundant or other safety features which exceed the general specifications of the PRODUCTS are required. For details, please contact the Mitsubishi representative in your region.

INTRODUCTION

Thank you for purchasing the Mitsubishi Electric MELSEC iQ-R series programmable controllers.

This manual describes the procedures, system configuration, and wiring of the relevant product listed below.

Before using this product, please read this manual and the relevant manuals carefully and develop familiarity with the functions and performance of the MELSEC iQ-R series programmable controller to handle the product correctly.

When applying the program examples provided in this manual to an actual system, ensure the applicability and confirm that it will not cause system control problems.

Please make sure that the end users read this manual.

Relevant product

RJ61BT11

COMPLIANCE WITH EMC AND LOW VOLTAGE DIRECTIVES

Method of ensuring compliance

To ensure that Mitsubishi Electric programmable controllers maintain EMC and Low Voltage Directives when incorporated into other machinery or equipment, certain measures may be necessary. Please refer to one of the following manuals.

- MELSEC iQ-R Module Configuration Manual
- Safety Guidelines (This manual is included with the base unit.)

The CE mark on the side of the programmable controller indicates compliance with EMC and Low Voltage Directives.

Additional measures

To ensure that this product maintains EMC and Low Voltage Directives, please refer to one of the following manuals.

- MELSEC iQ-R Module Configuration Manual
- Safety Guidelines (This manual is included with the base unit.)

MEMO

CONTENTS

SAFETY PRECAUTIONS	1
CONDITIONS OF USE FOR THE PRODUCT	8
INTRODUCTION	8
COMPLIANCE WITH EMC AND LOW VOLTAGE DIRECTIVES	9
RELEVANT MANUALS	12
TERMS	13
CHAPTER 1 PART NAMES	15
CHAPTER 2 SPECIFICATIONS	17
2.1 Performance Specifications	17
2.2 Maximum Number of Connectable Modules	19
2.3 Maximum Overall Cable Length	22
2.4 Ver.1.10-Compatible CC-Link Dedicated Cables	22
2.5 Modes	23
List of modes	23
CHAPTER 3 FUNCTION LIST	24
CHAPTER 4 PROCEDURES BEFORE OPERATION	27
CHAPTER 5 SYSTEM CONFIGURATION	29
5.1 CC-Link System Configuration	29
5.2 Precautions for the System Configuration	30
CHAPTER 6 WIRING	32
6.1 Terminal Block	32
6.2 Wiring Procedure	33
6.3 Product for Wiring	34
6.4 T-branch Connection	34
CHAPTER 7 COMMUNICATION EXAMPLES	36
7.1 Example of Communications Between a Master Station and a Remote Device Station	36
System configuration example	36
Settings for a master station	45
Settings for a remote device station	50
Checking the data link status	51
Program example	52
APPENDIX	55
Appendix 1 External Dimensions	55
INDEX	56
REVISIONS	58
WARRANTY	59
TRADEMARKS	60

RELEVANT MANUALS

Manual name [manual number]	Description	Available form
MELSEC iQ-R CC-Link System Master/Local Module User's Manual (Startup) [SH-081269ENG] (this manual)	Specifications, procedures before operation, system configuration, wiring, and communication examples of the CC-Link system master/local module	Print book e-Manual PDF
MELSEC iQ-R CC-Link System Master/Local Module User's Manual (Application) [SH-081270ENG]	Functions, parameter settings, programming, troubleshooting, I/O signals, and buffer memory of the CC-Link system master/local module	Print book e-Manual PDF
MELSEC iQ-R Programming Manual (Module Dedicated Instructions) [SH-081976ENG]	Dedicated instructions for the intelligent function modules	e-Manual PDF
iQ Sensor Solution Reference Manual [SH-081133ENG]	Operation methods of the online functions for iQ Sensor Solution	Print book e-Manual PDF

This manual does not include detailed information on the following:

- General specifications
- Applicable combinations of CPU modules and the other modules, and the number of mountable modules
- Installation

For details, refer to the following.

 MELSEC iQ-R Module Configuration Manual

This manual does not include information on the module function blocks.

For details, refer to the Function Block Reference for the module used.

Point



e-Manual refers to the Mitsubishi Electric FA electronic book manuals that can be browsed using a dedicated tool.

e-Manual has the following features:

- Required information can be cross-searched in multiple manuals.
- Other manuals can be accessed from the links in the manual.
- The hardware specifications of each part can be found from the product figures.
- Pages that users often browse can be bookmarked.

TERMS

Unless otherwise specified, this manual uses the following terms.

Term	Description
Buffer memory	Memory in an intelligent function module for storing data such as setting values and monitored values. When integrated into the CPU module, this memory refers to a memory for storing data such as setting values and monitored values of the Ethernet function, and data used for data communication of the multiple CPU system function.
Control system	A system that takes control and performs network communications in a redundant system
CPU module	A generic term for the MELSEC iQ-R series CPU modules
Cyclic transmission	A function by which data are periodically exchanged among stations on the same system using link devices
Data link	A generic term for cyclic transmission and transient transmission
Dedicated instruction	An instruction for using the functions of a module
Device	A device (X, Y, M, D, or others) in a CPU module
Device supporting iQSS	A generic term for a device which supports iQ Sensor Solution. For iQ Sensor Solution, refer to the following.  iQ Sensor Solution Reference Manual
Disconnection	A process of stopping data link if a data link error occurs
Engineering tool	Another term for the software package for the MELSEC programmable controllers
Global label	A label that is valid for all the program data when multiple program data are created in the project. There are two types of global label: a module specific label (module label), which is generated automatically by GX Works3, and an optional label, which can be created for any specified device.
Intelligent device station	A station that exchanges I/O signals (bit data) and I/O data (word data) with another station by cyclic transmission. This station responds to a transient transmission request from another station and also issues a transient transmission request to another station.
Intelligent function module	A module that has functions other than input and output, such as an A/D converter module and D/A converter module
Label	A label that represents a device in a given character string
Link device	A device (RX, RY, RWr, RWw, SB, or SW) in a CC-Link module
Link scan (link scan time)	Time required for all stations in a system to transmit data. The link scan time depends on data volume and the number of transient transmission requests.
Link special register (SW)	Word data that indicates the operating status and data link status of modules on the master and local stations
Link special relay (SB)	Bit data that indicates the operating status and data link status of modules on the master and local stations
Local station	A station that performs cyclic transmission and transient transmission with the master station and other local stations.
Master station	A station that controls the entire system. This station can perform cyclic transmission and transient transmission with all stations. Only one master station can be used in a system.
Master/local module	The abbreviation for the RJ61BT11 CC-Link system master/local module
Module label	A label that represents one of memory areas (I/O signals and buffer memory areas) specific to each module in a given character string. For the module used, GX Works3 automatically generates this label, which can be used as a global label.
RAS	The abbreviation for Reliability, Availability, and Serviceability. This term refers to usability of automated equipment.
Redundant system	A system consisting of two systems that have same configuration (CPU module, power supply module, network module, and other modules). Even after an error occurs in one of the two system, the other system takes over the control of the entire system. For details, refer to "Redundant system" of the following manual.  MELSEC iQ-R Module Configuration Manual
Remote device net Ver.1 mode	A mode used to configure a system only with a master station and Ver.1-compatible remote stations. More remote device stations can be connected compared to the remote net Ver.1 mode.
Remote device net Ver.2 mode	A mode used to configure a system only with remote stations containing master stations and Ver.2-compatible remote stations or to add Ver.2-compatible remote stations in future (a system only with master stations and Ver.1-compatible remote stations). More remote device stations can be connected compared to the remote net Ver.2 mode.
Remote device station	A station that exchanges I/O signals (bit data) and I/O data (word data) with the master station by cyclic transmission. This station cannot perform transient transmission.

Term	Description
Remote I/O net mode	A mode used to perform high-speed communications in a system consisting of a master station and remote I/O station(s) only
Remote I/O station	A station that exchanges I/O signals (bit data) with the master station by cyclic transmission This station cannot perform transient transmission.
Remote input (RX)	Bit data input from a slave station to the master station (For some areas in a local station, data are input in the opposite direction.)
Remote net Ver.1 mode	A mode used to configure a system only with a master station and Ver.1-compatible slave station. Data can be communicated with all stations (remote I/O station, remote device station, local station, intelligent device station, and standby master station) in a CC-Link system.
Remote net Ver.2 mode	A mode used to configure a system containing master stations and Ver.2-compatible slave stations or to add Ver.2-compatible slave stations in future. Data can be communicated with all stations (remote I/O station, remote device station, local station, intelligent device station, and standby master station) in a CC-Link system. Compared to the remote net Ver.1 mode, the number of cyclic points per station is increased from 128 to 896 for RX/RX, and from 16 to 128 for RWr/RWw.
Remote output (RY)	Bit data output from the master station to a slave station (For some areas in a local station, data are output in the opposite direction.)
Remote register (RWr)	Word data input from a slave station to the master station (For some areas in a local station, data are input in the opposite direction.)
Remote register (RWw)	Word data output from the master station to a slave station (For some areas in a local station, data are output in the opposite direction.)
Remote station	A generic term for a remote I/O station and a remote device station
Return	A process of restarting data link when a station recovers from an error
Slave station	A generic term for a remote I/O station, remote device station, local station, intelligent device station, and standby master station
Standby system	A backup system in a redundant system
System switching	A function which switches the systems between the control system and the standby system to continue operation of the redundant system when a failure or an error occurs in the control system
Transient transmission	A function of communication with another station, which is used when requested by a dedicated instruction or the engineering tool
Ver.1-compatible slave station	A slave station that supports the remote net Ver.1 mode or remote device net Ver.1 mode
Ver.2-compatible slave station	A slave station that supports the remote net Ver.2 mode or remote device net Ver.2 mode

1 PART NAMES

This section describes the part names of the master/local module.

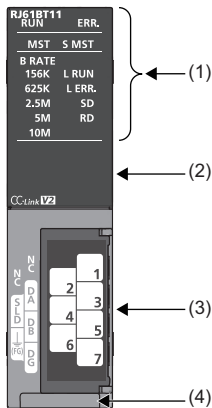

No.	Name	Description						
(1)	RUN LED	Indicates the operating status. On: Normal operation Off: A hardware error or a watchdog timer error has occurred.						
	ERR. LED	Indicates the error status of the module. The details of errors can be checked by using the following. <ul style="list-style-type: none"> • CC-Link diagnostics (MELSEC iQ-R CC-Link System Master/Local Module User's Manual (Application)) • 'Detailed LED display status' (SW0058) (MELSEC iQ-R CC-Link System Master/Local Module User's Manual (Application)) On: One of the following errors has occurred. <ul style="list-style-type: none"> • The error on all the stations was detected. • Two or more master stations are connected on the same line. • Settings are incorrect. • A cable is disconnected or a transmission path is affected by noise. Flashing: A station with a data link error was detected. Or the station number set for a remote station is already in use. Off: Normal operation						
	MST LED	Indicates whether the module is operating as a master station. On: Operating as a master station (during data link control) Off: Operating as a local station or a standby master station (in standby status)						
	S MST LED	Indicates whether the module is operating as a standby master station. On: Operating as a standby master station (in standby) Off: Operating as a master station or a local station						
	B RATE LED	<table border="1"> <tr> <td>156K</td> <td rowspan="5">Indicates the transmission speed that is normally operating. On: Operating at the indicated transmission speed All off: Transmission speed auto-tracking (When succeeded, the LED of the followed transmission speed turns on.)</td> </tr> <tr> <td>625K</td> </tr> <tr> <td>2.5M</td> </tr> <tr> <td>5M</td> </tr> <tr> <td>10M</td> </tr> </table>	156K	Indicates the transmission speed that is normally operating. On: Operating at the indicated transmission speed All off: Transmission speed auto-tracking (When succeeded, the LED of the followed transmission speed turns on.)	625K	2.5M	5M	10M
156K	Indicates the transmission speed that is normally operating. On: Operating at the indicated transmission speed All off: Transmission speed auto-tracking (When succeeded, the LED of the followed transmission speed turns on.)							
625K								
2.5M								
5M								
10M								
	L RUN LED	Indicates the data link status. On: Data link in progress Off: Data link not performed						
	L ERR. LED	Indicates the error status of a data link. On: A data link error has occurred at own station. Flashing: The communications are unstable due to the following reasons. <ul style="list-style-type: none"> • A terminating resistor is not connected. • The communications are affected by noise. Off: Normal operation						
	SD LED	Indicates whether the module is sending data. On: Data being sent Off: Data not sent						
	RD LED	Indicates whether the module is receiving data. On: Data being received Off: Data not received						

No.	Name	Description
(2)	Dot matrix LED	<p>Indicates the station number set in the module.</p> <p>The following is indicated during the offline or test mode.</p> <p>Offline: "..."</p> <p>Line test based on module parameter settings: "L.T."</p> <p>Hardware test: "H.T."</p>
(3)	Terminal block	<p>Used to connect a Ver.1.10-compatible CC-Link dedicated cable. (☞ Page 32 WIRING)</p> <p>The SLD and FG terminals are connected inside the module.</p> <p>Because a two-piece terminal block is used, the module can be replaced without disconnecting the signal line to the terminal block.</p> <p>Before installing or removing the terminal block, power off the module.</p>
(4)	Production information marking	Shows the product information (16 digits) of the module.

2 SPECIFICATIONS

This chapter describes the specifications of the master/local module.

2.1 Performance Specifications

This section describes the performance specifications of the master/local module.

Item		Description
Transmission speed		Selected from 156kbps, 625kbps, 2.5Mbps, 5Mbps, and 10Mbps.
Maximum number of connectable modules (master station)		64
Number of occupied stations (local station)		1 to 4 stations (The number of stations can be changed using the engineering tool.)
Maximum number of link points per system	CC-Link Ver.1	<ul style="list-style-type: none"> Remote I/O (RX, RY): 2048 points Remote register (RWw): 256 points (master station → remote device station/local station/intelligent device station/standby master station) Remote register (RWr): 256 points (remote device station/local station/intelligent device station/standby master station → master station)
	CC-Link Ver.2	<ul style="list-style-type: none"> Remote I/O (RX, RY): 8192 points Remote register (RWw): 2048 points (master station → remote device station/local station/intelligent device station/standby master station) Remote register (RWr): 2048 points (remote device station/local station/intelligent device station/standby master station → master station)
Number of link points per remote station/local station/intelligent device station/standby master station		☞ Page 18 Number of link points by the number of occupied stations
Communication method		Broadcast polling method
Synchronization method		Frame synchronization method
Encoding method		NRZI method
Network topology		Bus (RS-485)
Transmission format		HDLC compliant
Error control system		CRC ($X^{16} + X^{12} + X^5 + 1$)
Connection cable		Ver.1.10-compatible CC-Link dedicated cable
Maximum overall cable length (maximum transmission distance)		Depends on the transmission speed (☞ Page 22 Maximum Overall Cable Length)
Number of occupied I/O points		32 points
Internal current consumption (5VDC)		0.34A
External dimensions	Height	106mm (Base unit mounting side: 98mm)
	Width	27.8mm
	Depth	131mm
Weight		0.16kg

Number of link points by the number of occupied stations

The following table lists the number of link points by the number of occupied stations.

Item			CC-Link Ver.1	CC-Link Ver.2			
				Extended cyclic setting			
				Single	Double	Quadruple	Octuple
Number of link points by the number of occupied stations	1 station occupied	Remote I/O (RX, RY)	32 points (30 points for a local station)	32 points (30 points for a local station)	32 points (30 points for a local station)	64 points (62 points for a local station)	128 points (126 points for a local station)
		Remote register (RWw)	4 points	4 points	8 points	16 points	32 points
		Remote register (RWr)	4 points	4 points	8 points	16 points	32 points
	2 stations occupied	Remote I/O (RX, RY)	64 points (62 points for a local station)	64 points (62 points for a local station)	96 points (94 points for a local station)	192 points (190 points for a local station)	384 points (382 points for a local station)
		Remote register (RWw)	8 points	8 points	16 points	32 points	64 points
		Remote register (RWr)	8 points	8 points	16 points	32 points	64 points
	3 stations occupied	Remote I/O (RX, RY)	96 points (94 points for a local station)	96 points (94 points for a local station)	160 points (158 points for a local station)	320 points (318 points for a local station)	640 points (638 points for a local station)
		Remote register (RWw)	12 points	12 points	24 points	48 points	96 points
		Remote register (RWr)	12 points	12 points	24 points	48 points	96 points
	4 stations occupied	Remote I/O (RX, RY)	128 points (126 points for a local station)	128 points (126 points for a local station)	224 points (222 points for a local station)	448 points (446 points for a local station)	896 points (894 points for a local station)
		Remote register (RWw)	16 points	16 points	32 points	64 points	128 points
		Remote register (RWr)	16 points	16 points	32 points	64 points	128 points

2.2 Maximum Number of Connectable Modules

A CC-Link system can be configured with the number of modules satisfying the following conditions.

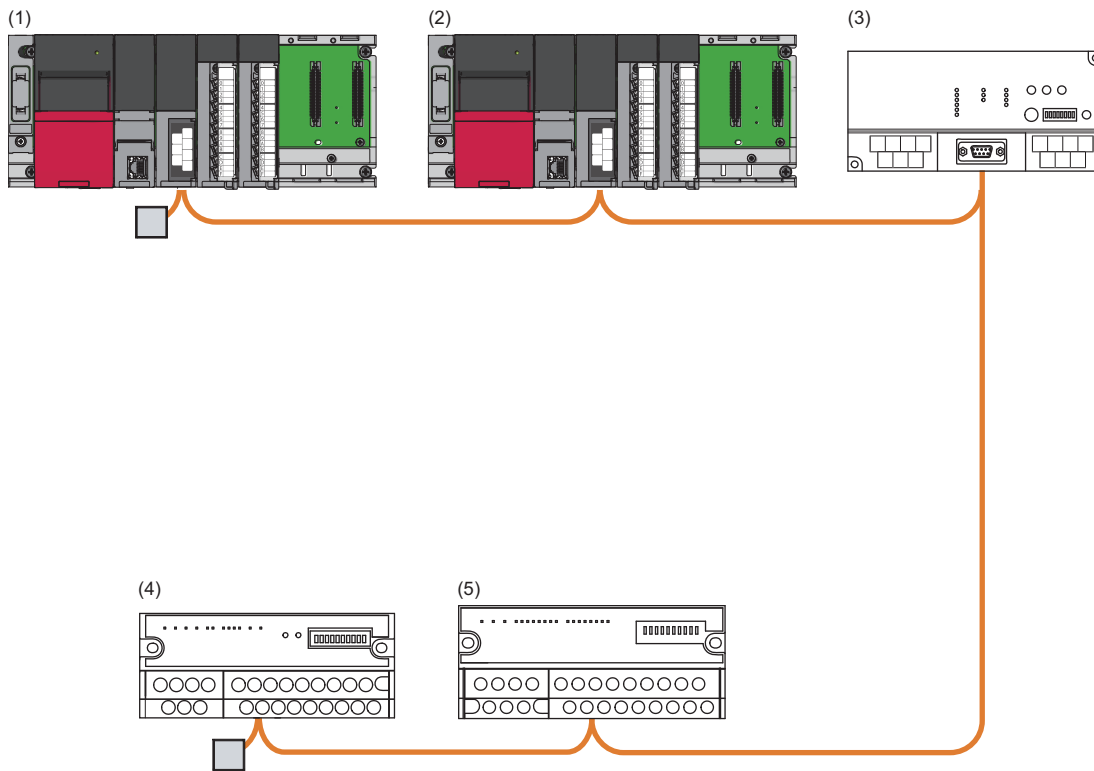

No.	Station type	Maximum number of connectable modules	
(1)	Master station	1 module in each system	
(2)	Local station	Up to 26 modules	Up to 64 modules
(3)	Intelligent device station		
(4)	Remote device station	Up to 64 modules	
(5)	Remote I/O station	Up to 64 modules	

Remote net Ver.1 mode

The following table lists the maximum number of connectable modules of when a system is configured only with Ver.1-compatible slave stations. For the modes, refer to the following.

☞ Page 23 Modes

For one master station, 64 modules of a remote I/O station, remote device station, local station, standby master station, and intelligent device station can be connected in total. Note, however, that the following conditions must be satisfied.

Item		Number of modules
Condition 1	$\{(1 \times a) + (2 \times b) + (3 \times c) + (4 \times d)\} \leq 64$	a: Number of modules occupying 1 station b: Number of modules occupying 2 stations c: Number of modules occupying 3 stations d: Number of modules occupying 4 stations
Condition 2	$\{(16 \times A) + (54 \times B) + (88 \times C)\} \leq 2304$	A: Number of remote I/O stations ≤ 64 B: Number of remote device stations ≤ 42 C: Number of local stations, standby master stations, and intelligent device stations ≤ 26

Remote net Ver.2 mode

The following table lists the maximum number of connectable modules of when a system is configured only with Ver.2-compatible slave stations. For the modes, refer to the following.

☞ Page 23 Modes

For one master station, 64 modules of a remote I/O station, remote device station, local station, standby master station, and intelligent device station can be connected in total. Note, however, that the following conditions must be satisfied.

Item		Number of modules
Condition 1	$\{(a + a2 + a4 + a8) + (b + b2 + b4 + b8) \times 2 + (c + c2 + c4 + c8) \times 3 + (d + d2 + d4 + d8) \times 4\} \leq 64$	a: Total number of Ver.1-compatible slave stations occupying 1 station and Ver.2-compatible slave stations occupying 1 station (extended cyclic setting: single) b: Total number of Ver.1-compatible slave stations occupying 2 stations and Ver.2-compatible slave stations occupying 2 stations (extended cyclic setting: single)
Condition 2	$\{[(a \times 32) + (a2 \times 32) + (a4 \times 64) + (a8 \times 128)] + \{(b \times 64) + (b2 \times 96) + (b4 \times 192) + (b8 \times 384)\} + \{(c \times 96) + (c2 \times 160) + (c4 \times 320) + (c8 \times 640)\} + \{(d \times 128) + (d2 \times 224) + (d4 \times 448) + (d8 \times 896)\}\} \leq 8192$	c: Total number of Ver.1-compatible slave stations occupying 3 stations and Ver.2-compatible slave stations occupying 3 stations (extended cyclic setting: single)
Condition 3	$\{[(a \times 4) + (a2 \times 8) + (a4 \times 16) + (a8 \times 32)] + \{(b \times 8) + (b2 \times 16) + (b4 \times 32) + (b8 \times 64)\} + \{(c \times 12) + (c2 \times 24) + (c4 \times 48) + (c8 \times 96)\} + \{(d \times 16) + (d2 \times 32) + (d4 \times 64) + (d8 \times 128)\}\} \leq 2048$	d: Total number of Ver.1-compatible slave stations occupying 4 stations and Ver.2-compatible slave stations occupying 4 stations (extended cyclic setting: single) a2: Number of Ver.2-compatible slave stations occupying 1 station (extended cyclic setting: double) b2: Number of Ver.2-compatible slave stations occupying 2 stations (extended cyclic setting: double) c2: Number of Ver.2-compatible slave stations occupying 3 stations (extended cyclic setting: double) d2: Number of Ver.2-compatible slave stations occupying 4 stations (extended cyclic setting: double) a4: Number of Ver.2-compatible slave stations occupying 1 station (extended cyclic setting: quadruple) b4: Number of Ver.2-compatible slave stations occupying 2 stations (extended cyclic setting: quadruple) c4: Number of Ver.2-compatible slave stations occupying 3 stations (extended cyclic setting: quadruple) d4: Number of Ver.2-compatible slave stations occupying 4 stations (extended cyclic setting: quadruple) a8: Number of Ver.2-compatible slave stations occupying 1 station (extended cyclic setting: octuple) b8: Number of Ver.2-compatible slave stations occupying 2 stations (extended cyclic setting: octuple) c8: Number of Ver.2-compatible slave stations occupying 3 stations (extended cyclic setting: octuple) d8: Number of Ver.2-compatible slave stations occupying 4 stations (extended cyclic setting: octuple)
Condition 4	$\{(16 \times A) + (54 \times B) + (88 \times C)\} \leq 2304$	A: Number of remote I/O stations ≤ 64 B: Number of remote device stations ≤ 42 C: Number of local stations, standby master stations, and intelligent device stations ≤ 26

Remote device net Ver.1 mode

The following table lists the maximum number of connectable modules for a system configured in the remote device net Ver.1 mode. For the modes, refer to the following.

☞ Page 23 Modes

For one master station, 64 modules of a remote I/O station and remote device station can be connected in total. Note, however, that the following conditions must be satisfied.

Item	Number of modules
Condition 1	$\{(1 \times a) + (2 \times b) + (3 \times c) + (4 \times d)\} \leq 64$ <p>a: Number of modules occupying 1 station b: Number of modules occupying 2 stations c: Number of modules occupying 3 stations d: Number of modules occupying 4 stations</p>

Remote device net Ver.2 mode

The following table lists the maximum number of connectable modules for a system configured in the remote device net Ver.2 mode. For the modes, refer to the following.

☞ Page 23 Modes

For one master station, 64 modules of a remote I/O station and remote device station can be connected in total. Note, however, that the following conditions must be satisfied.

Item	Number of modules	
Condition 1	<p>a: Total number of Ver.1-compatible remote stations occupying 1 station and Ver.2-compatible remote device stations occupying 1 station (extended cyclic setting: single)</p> <p>b: Total number of Ver.1-compatible remote stations occupying 2 stations and Ver.2-compatible remote device stations occupying 2 stations (extended cyclic setting: single)</p> <p>c: Total number of Ver.1-compatible remote stations occupying 3 stations and Ver.2-compatible remote device stations occupying 3 stations (extended cyclic setting: single)</p> <p>d: Total number of Ver.1-compatible remote stations occupying 4 stations and Ver.2-compatible remote device stations occupying 4 stations (extended cyclic setting: single)</p> <p>a2: Number of Ver.2-compatible remote device stations occupying 1 station (extended cyclic setting: double)</p> <p>b2: Number of Ver.2-compatible remote device stations occupying 2 stations (extended cyclic setting: double)</p> <p>c2: Number of Ver.2-compatible remote device stations occupying 3 stations (extended cyclic setting: double)</p> <p>d2: Number of Ver.2-compatible remote device stations occupying 4 stations (extended cyclic setting: double)</p> <p>a4: Number of Ver.2-compatible remote device stations occupying 1 station (extended cyclic setting: quadruple)</p> <p>b4: Number of Ver.2-compatible remote device stations occupying 2 stations (extended cyclic setting: quadruple)</p> <p>c4: Number of Ver.2-compatible remote device stations occupying 3 stations (extended cyclic setting: quadruple)</p> <p>d4: Number of Ver.2-compatible remote device stations occupying 4 stations (extended cyclic setting: quadruple)</p> <p>a8: Number of Ver.2-compatible remote device stations occupying 1 station (extended cyclic setting: octuple)</p> <p>b8: Number of Ver.2-compatible remote device stations occupying 2 stations (extended cyclic setting: octuple)</p> <p>c8: Number of Ver.2-compatible remote device stations occupying 3 stations (extended cyclic setting: octuple)</p> <p>d8: Number of Ver.2-compatible remote device stations occupying 4 stations (extended cyclic setting: octuple)</p>	
Condition 2		$\{(a \times 32) + (a2 \times 32) + (a4 \times 64) + (a8 \times 128)\} + \{(b \times 64) + (b2 \times 96) + (b4 \times 192) + (b8 \times 384)\} + \{(c \times 96) + (c2 \times 160) + (c4 \times 320) + (c8 \times 640)\} + \{(d \times 128) + (d2 \times 224) + (d4 \times 448) + (d8 \times 896)\} \leq 8192$
Condition 3		$\{(a \times 4) + (a2 \times 8) + (a4 \times 16) + (a8 \times 32)\} + \{(b \times 8) + (b2 \times 16) + (b4 \times 32) + (b8 \times 64)\} + \{(c \times 12) + (c2 \times 24) + (c4 \times 48) + (c8 \times 96)\} + \{(d \times 16) + (d2 \times 32) + (d4 \times 64) + (d8 \times 128)\} \leq 2048$

Remote I/O net mode

The maximum number of connectable modules for a system configured in the remote I/O net mode is 64 stations. For the modes, refer to the following.

☞ Page 23 Modes

2.3 Maximum Overall Cable Length

This section describes how transmission speed, a station-to-station cable length (1), and maximum overall cable length (2) are related when a system is configured with products of CC-Link Ver.1.10 or later and Ver.1.10-compatible CC-Link dedicated cables.

For the identification of the CC-Link Version, refer to the installation manual issued by the CC-Link Partner Association.

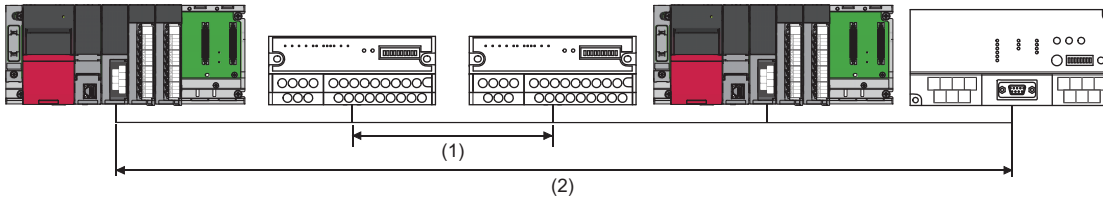

- Ver.1.10-compatible CC-Link dedicated cable (a terminating resistor of 110Ω used)

Transmission speed	Station-to-station cable length	Maximum overall cable length
156kbps	20cm or more	1200m
625kbps		900m
2.5Mbps		400m
5Mbps		160m
10Mbps		100m

2.4 Ver.1.10-Compatible CC-Link Dedicated Cables

Use Ver.1.10-compatible CC-Link dedicated cables for the CC-Link system.

If not, the performance of the CC-Link system is not guaranteed.

For the specifications of Ver.1.10 compatible CC-Link dedicated cables and contact information, refer to the following.
Website of CC-Link Association: www.cc-link.org



For details, refer to the CC-Link Cable Wiring Manual issued by CC-Link Partner Association.

2.5 Modes

Select the mode according to the system used for the master/local module. Depending on the mode, the addresses of storage positions for RX, RY, RWr, and RWW differ.

List of modes

Mode	Application	Connectable slave station
Remote net Ver.1 mode	To configure a new system (only with Ver.1-compatible slave stations)	Ver.1-compatible slave station
Remote net Ver.2 mode	<ul style="list-style-type: none">To configure a system including a Ver.2-compatible slave stationMore points are used compared to the remote net Ver.1 mode.	Ver.1-compatible slave station and Ver.2-compatible slave station
Remote device net Ver.1 mode ^{*1}	<ul style="list-style-type: none">To configure a system only with Ver.1-compatible remote stationsMore remote device stations are used compared to the remote net Ver.1 mode.	Ver.1-compatible remote station
Remote device net Ver.2 mode ^{*1}	<ul style="list-style-type: none">To configure a system only with remote stations containing Ver.2-compatible remote stationsMore remote device stations are used compared to the remote net Ver.2 mode.	Ver.1-compatible remote station and Ver.2-compatible remote station
Remote I/O net mode ^{*1}	To configure a system only with remote I/O stations	Remote I/O station

*1 This mode cannot be selected when "Station Type" under "Required Settings" is set to something other than "Master Station".



For details on modes, refer to the following.

MELSEC iQ-R CC-Link System Master/Local Module User's Manual (Application)

3 FUNCTION LIST

Cyclic transmission

This section describes the functions of the CC-Link system. For details on the functions, refer to the following.

📖 MELSEC iQ-R CC-Link System Master/Local Module User's Manual (Application)

○: Available, △: Partially available, ×: Not available

Function		Description	Availability		
			Master station	Local station	Standby master station
Communications with other stations	Communications using RX and RY	Communicates I/O data in units of bits between the master station and other stations.	○	○	○
	Communications using RWr and RWw	Communicates I/O data in units of words between the master station and other stations.			
Mode	Remote net Ver.1 mode	The mode can be selected according to the CC-Link system configuration.	○	○	○
	Remote net Ver.2 mode				
	Remote device net Ver.1 mode		△ ^{*1}	×	×
	Remote device net Ver.2 mode				
	Remote I/O net mode				
Link refresh		Automatically transfers data between the link device of the master/local module and the device of the CPU module.	○	○	○
Cyclic data integrity assurance		Prevents read/write data from being separated between new and old data.	○	○	○
Sequence scan synchronization specification		Selects whether link scan is set to asynchronous or synchronous with the sequence scan of the CPU module.	○	×	×
Setting of the input data from a data link faulty station		Selects whether I/O data from a station where a data link error occurs is cleared or held.	○	○	○
Output data setting for CPU STOP		Selects whether remote output (RY) is refreshed (held at the value before STOP) or cleared to zero (0) when the CPU module is set to STOP.	○	○	○
Data link setting when CPU is down		Selects whether data link is stopped or continued when a stop error occurs in the CPU module which a master/local module is mounted with.	△ ^{*2}	×	×
Data link stop and restart		Stops data link during debugging and other operations. (Data sending from the own station is stopped.) Also, the stopped data link is restarted.	○	○	○
Remote I/O station points setting		Selects the number of refresh points with a remote I/O station from 8 points, 16 points, and 32 points when the master station is in the remote net Ver.2 mode or remote device net Ver.2 mode. Changing the number of points can save the areas of the refresh device in a CPU module. (In modes other than the remote net Ver.2 mode and remote device net Ver.2 mode, only 32 points per station can be selected.)	○	×	×

*1 When "Master Station (Duplex Function)" is selected for the station type, this function cannot be used.

*2 When "Master Station (Duplex Function)" is selected for the station type, the setting in which data link is continued is not available.

Transient transmission

○: Available, ×: Not available

Function	Description	Availability		
		Master station	Local station	Standby master station
Communications in the same system	Performs the transient transmission to other stations using dedicated instructions and the engineering tool.	○	○	○
Communications with different networks	Performs the transient transmission seamlessly to stations on different networks using the engineering tool.	○	○	○
Dedicated instruction	An instruction for using functions of modules.	○	○	○

RAS

○: Available, ×: Not available

Function	Description	Availability		
		Master station	Local station	Standby master station
Slave station cutoff function	Disconnects only the slave station where an error occurs from the system, and continues the data link with the stations that are operating normally. (No module parameter setting is required.)	○	×	○
Automatic return function	Automatically returns the station disconnected from the system due to a data link error to the system when it recovers and restarts data link.	○	×	○
Standby master function	Allows the standby master station to control slave stations instead of the master station when the master station is disconnected in a system where the master station and standby master station are connected on the same system. Using this function prevents the entire system from going down due to disconnection of the master station.	○	×	○



Diagnostics

○: Available, ×: Not available

Function	Description	Availability		
		Master station	Local station	Standby master station
Line test	Checks whether a Ver.1.10-compatible CC-Link dedicated cable is properly connected and data link can be performed with slave stations.	○	○	○
Check of transmission speed setting	Checks whether the transmission speed setting of a slave station is the same as that of the master station. The station number of the slave station having a different transmission speed setting can be also checked; therefore, corrective action upon a transmission error can be easily taken.	○	○	○
CC-Link diagnostics	Checks the status of CC-Link system using the engineering tool. The error locations, error causes, and corrective actions can be checked in the engineering tool.	○	○	○
Hardware test	Checks the hardware in the master/local module.	○	○	○

Others

○: Available, ×: Not available

Function	Description	Availability		
		Master station	Local station	Standby master station
Reserved station function	Prevents slave stations that are not actually connected (but will be connected in future) from detecting as "Data Link Faulty Station" in the master station and local station. By setting slave stations that will be connected in future as reserved stations, slave stations can be added without a program change because the RX, RY, RWr, or RWW assignment is not changed. In addition, the number of points of a slave station that has been set as a reserved station can be set to zero points.	○	×	×
Error invalid station setting function	Prevents a slave station from being detected as a faulty station in the master station and local station even if a data link error occurs in the slave station. This function is used when a slave station is powered off as a matter of the system configuration or for other purposes.	○	×	×
Temporary error invalid station setting function	Prevents a slave station from being detected as a faulty station in the master station and local station even if a data link error occurs in the slave station. This setting can be configured even during data link, unlike the error invalid station setting function. This function is used to exchange slave stations for maintenance or for other purposes during data link.	○	×	×
Interrupt setting function	Issues an interrupt request to a CPU module when the interrupt conditions that have been set using an engineering tool are satisfied, and executes the interrupt program. This function is used to stop the control and execute an interrupt program upon an error or for other purposes.	○	○	○
Remote device station initial setting procedure registration function	Registers in advance the initial setting of a remote device station which is performed on a program using an engineering tool and saves the setting by turning on the link special relay (SB). A program for the initial setting is not required.	○	×	×
Master station duplication error canceling function	Clears a master station duplication error without resetting the CPU module or powering off and on the system when the error has been detected.	○	×	×
Transmission speed auto-tracking function on local stations	Automatically tracks the transmission speed of the master station when the own station is a local station or standby master station. This function eliminates transmission speed setting errors.	×	○	○
Automatic detection of connected device	Detects devices supporting iQSS which are connected to the RJ61BT11, and automatically displays them on "List of devices" and "Device map area" using an engineering tool. For details, refer to the following.  iQ Sensor Solution Reference Manual	○	×	×
iQ Sensor Solution data backup/restoration function	Backs up the setting data of the slave station into the SD memory card of the CPU module on the master station. The setting data backed up on the SD memory card of the CPU module on the master station is restored into the slave module. For details, refer to the following.  iQ Sensor Solution Reference Manual	○	×	×

4 PROCEDURES BEFORE OPERATION

This chapter describes the procedures before operation.

1. System configuration

Configure the CC-Link system and set the parameters which are required for start-up, the station number for the slave station, and the transmission speed.

- Wiring (📄 Page 32 WIRING)
- Parameter settings (📖 MELSEC iQ-R CC-Link System Master/Local Module User's Manual (Application))
- Slave station number and transmission speed settings (📖 manual for slave station being used)

2. Check operation using LED

Turn on the power and check whether the data link is being implemented properly.

If the data link is implemented properly, the LED On status will be as follows.

- L RUN LED: On
- ERR. LED: Off

3. Programming

Program is created. For details, refer to the following.

📖 MELSEC iQ-R CC-Link System Master/Local Module User's Manual (Application)

MEMO

5 SYSTEM CONFIGURATION

5.1 CC-Link System Configuration

A CC-Link system is configured with a master station (1), remote I/O station (2), remote device station (3), intelligent device station (4), and local station (5).

Connect the terminating resistors (6) to the stations at both ends.

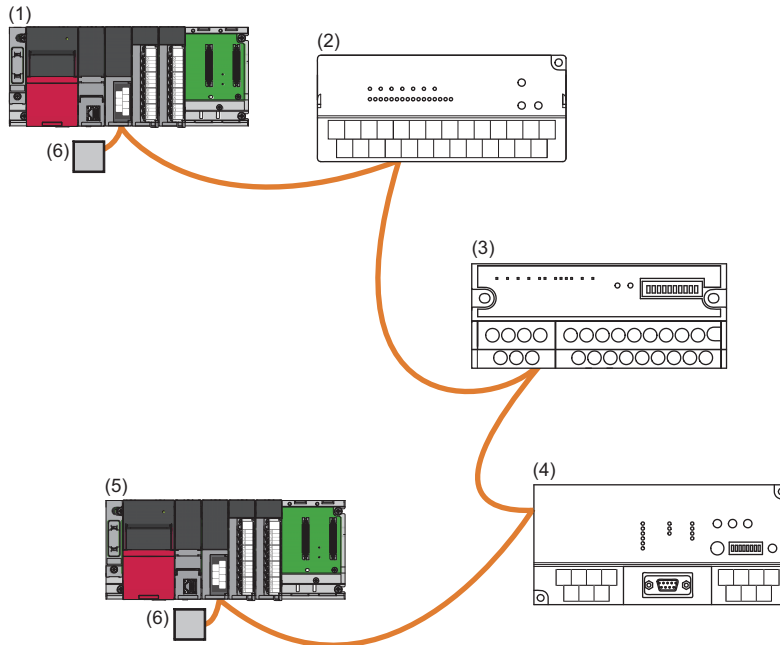

The CC-Link version and the number of slave stations that can be connected vary depending on the mode of the master/local module. (➡ Page 19 Maximum Number of Connectable Modules)

Master/local modules of other series can be also used in a CC-Link system.

Point

For applicable CPU modules and the number of mountable modules, refer to the following.

📖 MELSEC iQ-R Module Configuration Manual

Use in a redundant system

The master/local module can be used in a redundant system.

The standby master function allows tracking to a system switching due to an error in the control system power supply module or a stop error in the CPU module.

For details, refer to the following.

📖 MELSEC iQ-R CC-Link System Master/Local Module User's Manual (Application)

5.2 Precautions for the System Configuration

Please consider the following for system design to prevent incorrect input from a remote station.

When turning on and off the power

Power on the remote station, then start data link. In addition, stop data link before turning off the remote station. Failure to do so may cause an incorrect input.

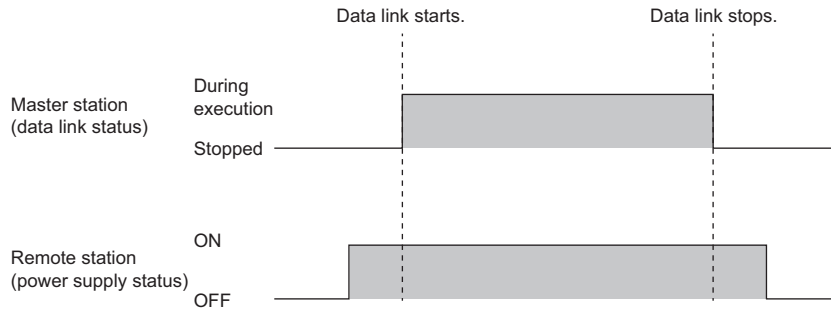

Upon a momentary power failure of a remote station

If a momentary power failure occurs in the power supply (24VDC) of the remote station, an incorrect input may occur.

■Cause of an incorrect input due to a momentary power failure

The hardware of a remote station internally converts the power supply of a module (24VDC) into 5VDC. If an instantaneous power failure occurs at a remote station, (the time until the 5VDC power supply in the remote station turns off) > (the response time after an input module turns on and off); therefore, refreshing data within the time as shown in ① below causes an incorrect input.

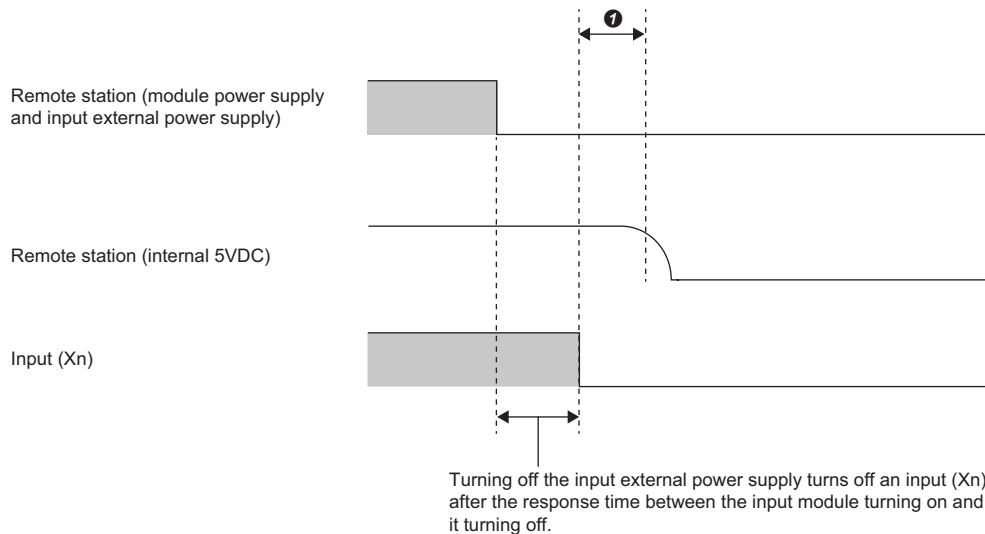

■Countermeasure against an incorrect input

Supply power to the power supply module, stabilized power supply, and AC input external power supply from the same power supply.

Point

When supplying power to multiple remote stations from one power supply, select applicable cables and properly wire them to prevent a voltage drop caused by the power supply. When a remote station has a receiving end voltage within the specified range for the remote station used, it can be connected.

Access to a station with the station number 64

■ Access from other stations using an engineering tool and GOT

Access to a local station with the station number 64 cannot be performed from other stations. Changing the station number to the one other than 64 allows access from other stations.

■ Access to other stations using a CC-Link system master/local interface board

Access to a local station and intelligent device station with the station number 64 cannot be performed from other stations. Changing the station number to the one other than 64 allows access from other stations.

6 WIRING

This chapter describes the specifications of the master/local module wiring.

6.1 Terminal Block

Screws and tightening torque

Tighten the terminal block screws within the specified torque range.

Screw type	Tightening torque range
Terminal block screw (M3 screw)	0.42 to 0.58N·m
Terminal block mounting screw (M3.5 screw)	0.66 to 0.89N·m

Solderless terminal

Use a solderless terminal and wire specified in the following table. Tighten a solderless terminal within the specified torque range. Use a UL certified solderless terminal and use a tool recommended by the solderless terminal manufacturer for forming.

Solderless terminals with sleeves cannot be used.

Solderless terminal		Wire			
Model	Applicable tightening torque	Diameter	Type	Material	Temperature rating
R1.25-3	0.42 to 0.58N·m	0.3 to 1.25mm ² (22 to 16 AWG)	Stranded	Copper	60°C or more

Point

Solderless terminals with insulation sleeves cannot be used for the terminal block. It is recommended to cover the connecting sections of the solderless terminals with a marking tube or insulation tube.

Signal name for terminal block

Shows the signal name for the terminal block

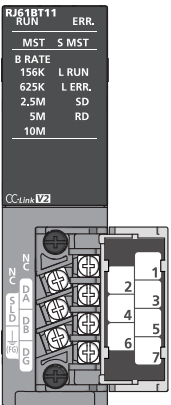
Terminal block	Terminal number	Signal name
	1	NC
	2	NC
	3	DA
	4	SLD
	5	DB
	6	FG
	7	DG

6.2 Wiring Procedure

Wiring to terminal block

This section describes wiring to the terminal block.

Connect a Ver.1.10-compatible CC-Link dedicated cable as shown below.

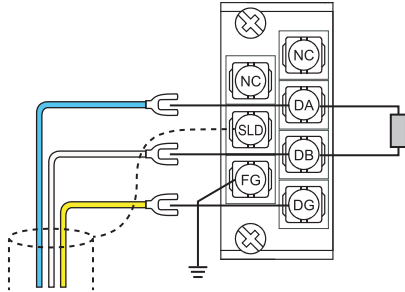

Ver.1.10-compatible CC-Link dedicated cable	Terminal to connect
DA line (blue)	DA
DB line (white)	DB
DG line (yellow)	DG
Shield wire	SLD

6

Point

- Connect the terminating resistors between the DA and DB terminals.
- Connect the shield wires of a Ver.1.10 compatible CC-Link dedicated cable to the SLD terminal through the FG terminal. Then ground the cables at both ends with a ground resistance of 100 ohms or less. The SLD and FG terminals are connected inside.
- For the terminal processing of when connecting the Ver.1.10-compatible CC-Link dedicated cable to the terminal block, do not unfasten the DA/DB/DG cable (three wires in one cable) or remove the sheath more than necessary. (For cables with fillers, cut them using a tool.)

Wiring example

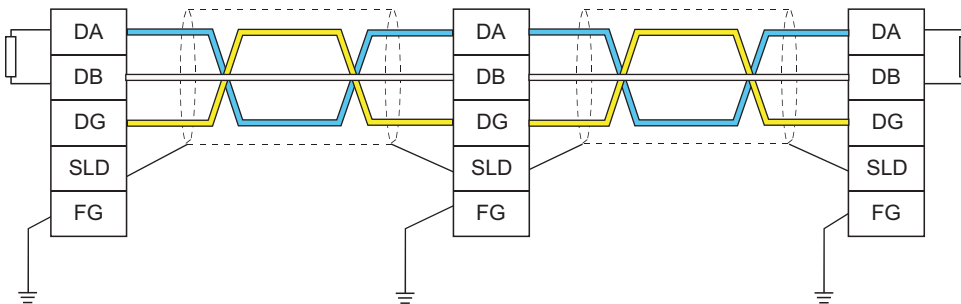

Point

- No restrictions apply to the connection order of a master/local module. (The cables need not be connected in the order of station number.)
- The star topology cannot be used. Note, however, that the T-branch connection can be used. (➡ Page 34 T-branch Connection)

6.3 Product for Wiring

Cables that can be used

Use Ver.1.10 compatible CC-Link dedicated cables.

Note, the cables need not be connected in the order of station number.

Terminating resistor to be used

Connect the terminating resistors included with the modules at both ends of the modules in the CC-Link system.



6.4 T-branch Connection

This section describes how to connect the Ver.1.10 compatible CC-Link dedicated cables in T-branch.

T-branch system configuration

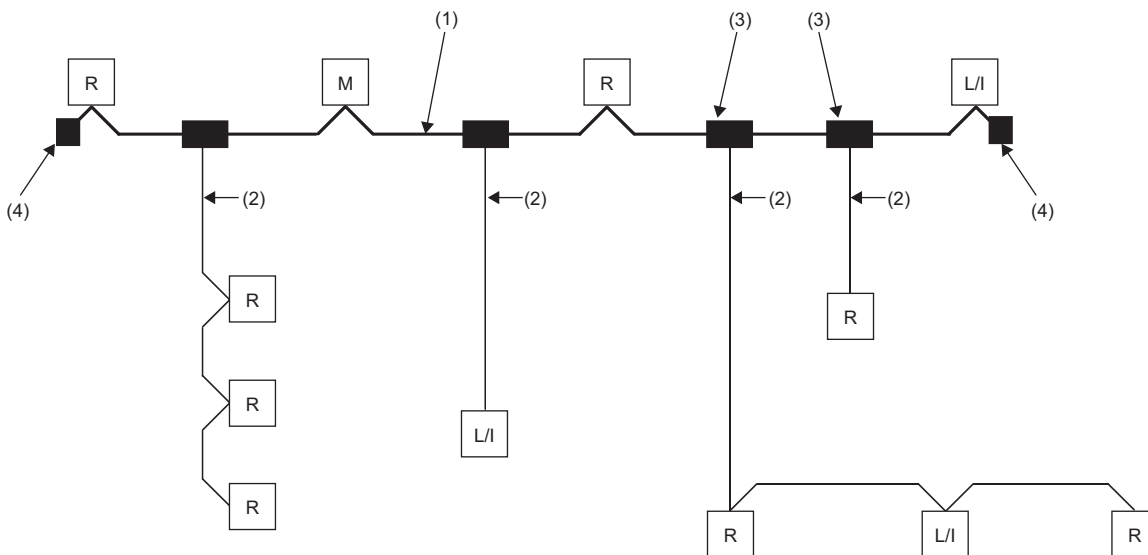
The following is a system configuration in T-branch.



-  Master station
-  Remote I/O station or remote device station
-  Local station or intelligent device station

- (1) Main line
- (2) Branch line
- (3) T-branch terminal block or T-branch connector
- (4) Terminating resistor



The number of branch lines is determined by the branch line length per branch line and the overall branch line length.

Communication specifications for a T-branch connection

The following table lists the communication specifications upon T-branch connection.

For those not listed below, refer to the performance specifications. (Page 17 Performance Specifications)

Item	Specifications		Remarks
Transmission speed	625kbps	156kbps	10M, 5M, and 2.5Mbps cannot be used.
Maximum length of the main line	100m	500m	A cable length between terminating resistors. The length (branch line length) of a T-branch cable is not included.
Maximum length of the branch line	8m		A total cable length for each branch
Overall branch line length	50m	200m	A total length of all branch cables
Maximum number of connected modules on the branch line	6 stations per branch		The total number of connected stations depends on the CC-Link specifications.
Connection cable	Ver.1.10-compatible CC-Link dedicated cable		—
T branch terminal block	Commercially available terminal block		Do not remove the jacket of the cables on the branch line, if possible.
T branch connector	A connector for an FA sensor conforming to NECA4202 (IEC947-5-2) or equivalent product is recommended. (NECA: Nippon Electric Control Equipment Industries Association)		

Maximum length of the main line, distance between T-branches, and cable length between stations

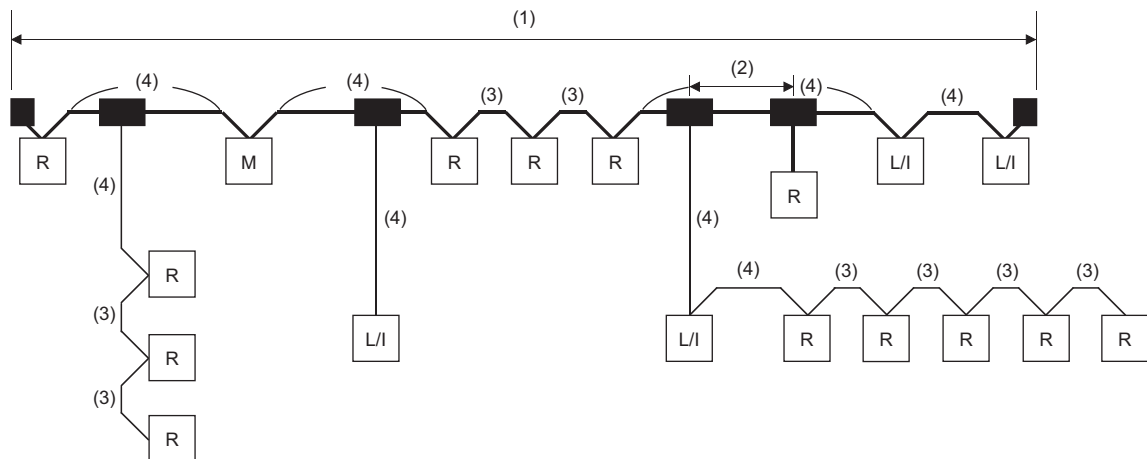

- M Master station
- R Remote I/O station or remote device station
- L/I Local station or intelligent device station

No.	Item	Transmission speed	
		625kbps	156kbps
(1)	Maximum length of the main line (not including the branch line length)	100m	500m
(2)	Distance between T branches	No restriction	
(3)	Station-to-station cable length between remote I/O stations or remote device stations	30cm or more	
(4)	Station-to-station cable length between a master station, local station, or intelligent device station and an adjacent station to the front or back	1m or more *1/2m or more*2	

*1 This applies to a system configuration with a remote I/O station and remote device station.

*2 This applies to a system configuration including a local station and intelligent device station.

7 COMMUNICATION EXAMPLES

This chapter describes programming and start-up examples of the master/local module.

7.1 Example of Communications Between a Master Station and a Remote Device Station

This section describes an example of how to set the initial settings for the remote device station and perform an analog input and analog output.

If an error occurs, the error code of the remote device station is stored in the device of a CPU module or the module label.

System configuration example

The following system configuration is used to explain communication between the master station and remote device station.

System configuration

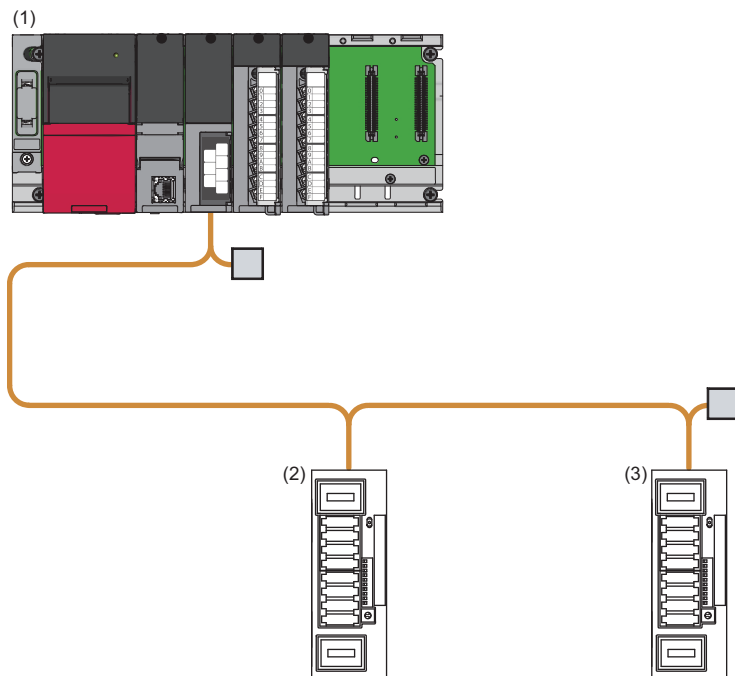

No.	Model	Station type	Start I/O No.	Station No.	No. of occupied stations
(1)	R04CPU	—			
	RJ61BT11	Master station	X/Y00 to X/Y1F	0	—
	RX10	—	X/Y20 to X/Y2F	—	
	RY10R2	—	X/Y30 to X/Y3F	—	
(2)	AJ65VBTCU-68ADV	Remote device station	—	1	3
(3)	AJ65VBTCU-68DAV	Remote device station	—	4	3

Link device assignment

This section describes the RX, RY, RWr, or RWw assignment of program examples.

Point

- Remote net Ver.1 mode is used in this program examples. When the remote net Ver.2 mode or remote device net Ver.2 mode is used, the buffer memory addresses of storage locations vary. (Page 20 Remote net Ver.1 mode)
- For details on the signals of the RX/RX and RWr/RWw of the AJ65VBTCU-68ADV and AJ65VBTCU-68DAVN, refer to the manual for the remote station used.

■RX assignment

Each number in the figure, No.1 and No.4, represents a station number.

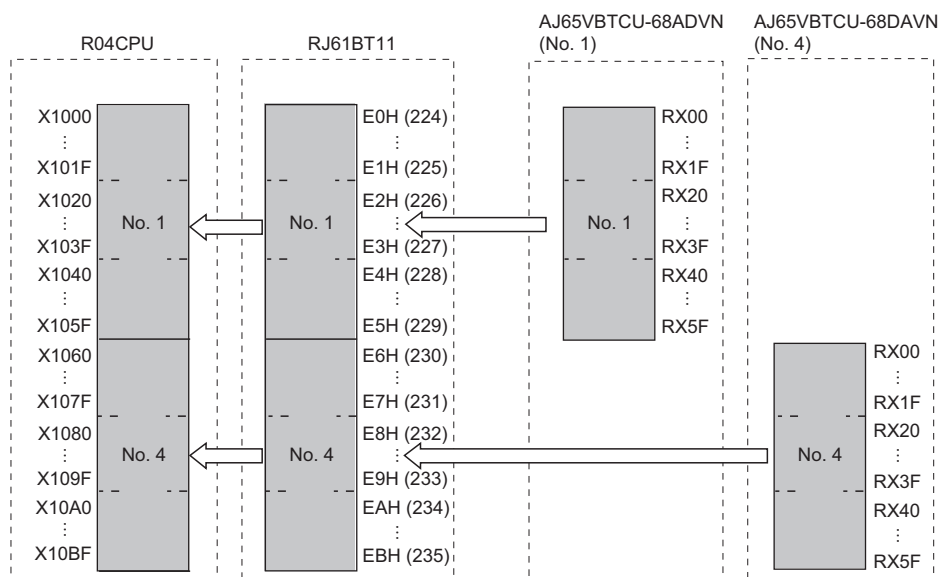

R04CPU Device	RJ61BT11 Buffer memory address		Slave station		
	Hexadecimal	Decimal	Station No.	Module name	RX
X1000 to X100F	E0H	224	1	AJ65VBTCU-68ADV	RX0 to RXF
X1010 to X101F	E1H	225			RX10 to RX1F
X1020 to X102F	E2H	226			RX20 to RX2F
X1030 to X103F	E3H	227			RX30 to RX3F
X1040 to X104F	E4H	228			RX40 to RX4F
X1050 to X105F	E5H	229			RX50 to RX5F
X1060 to X106F	E6H	230	4	AJ65VBTCU-68DAVN	RX0 to RXF
X1070 to X107F	E7H	231			RX10 to RX1F
X1080 to X108F	E8H	232			RX20 to RX2F
X1090 to X109F	E9H	233			RX30 to RX3F
X10A0 to X10AF	EAH	234			RX40 to RX4F
X10B0 to X10BF	EBH	235			RX50 to RX5F

The assignment by each signal of the AJ65VBTCU-68ADVN and AJ65VBTCU-68DAVN are shown below.

CPU module	Remote station		
Device	Module name	RX	Signal name
X1000	AJ65VBTCU-68ADVN	RX00	CH.1 A/D conversion completion flag
X1001		RX01	CH.2 A/D conversion completion flag
X1002		RX02	CH.3 A/D conversion completion flag
X1003		RX03	CH.4 A/D conversion completion flag
X1004		RX04	CH.5 A/D conversion completion flag
X1005		RX05	CH.6 A/D conversion completion flag
X1006		RX06	CH.7 A/D conversion completion flag
X1007		RX07	CH.8 A/D conversion completion flag
X1008		RX08	Use prohibited
to		to	
X100B		RX0B	
X100C		RX0C	E ² PROM write error flag
X100D		RX0D	Use prohibited
to		to	
X1017		RX17	
X1018		RX18	Initial data processing request flag
X1019		RX19	Initial data setting completion flag
X101A		RX1A	Error status flag
X101B		RX1B	Remote READY
X101C		RX1C	Use prohibited
to	to		
X105F	RX5F		
X1060	AJ65VBTCU-68DAVN	RX00	Use prohibited
to		to	
X106B		RX0B	
X106C		RX0C	E ² PROM write error flag
X106D		RX0D	Use prohibited
to		to	
X1077		RX17	
X1078		RX18	Initial data processing request flag
X1079		RX19	Initial data setting completion flag
X107A		RX1A	Error status flag
X107B		RX1B	Remote READY
X107C		RX1C	Use prohibited
to		to	
X10BF		RX5F	

RY assignment

Each number in the figure, No.1 and No.4, represents a station number.

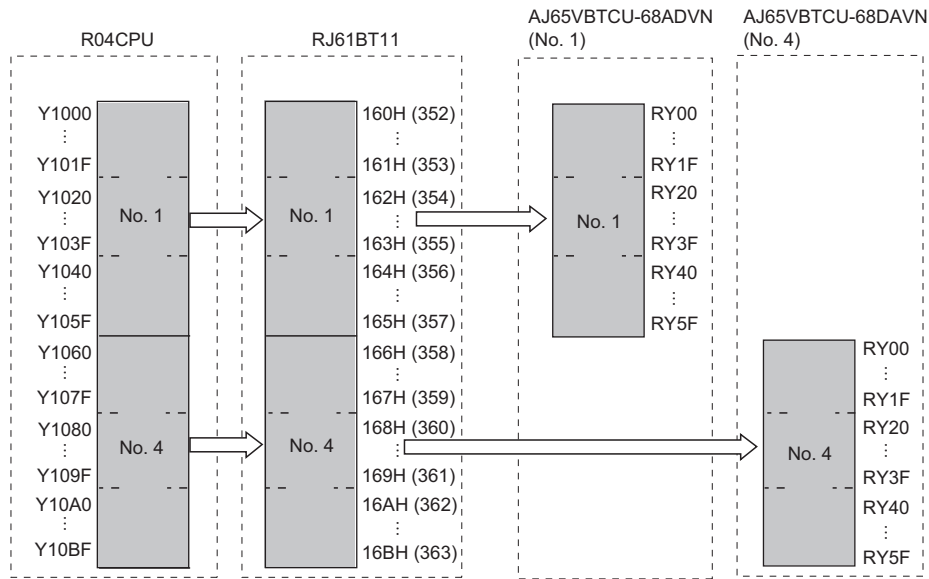

R04CPU Device	RJ61BT11 Buffer memory address		Slave station		
	Hexadecimal	Decimal	Station No.	Module name	RY
Y1000 to Y100F	160H	352	1	AJ65VBTCU-68ADVN	RY0 to RYF
Y1010 to Y101F	161H	353			RY10 to RY1F
Y1020 to Y102F	162H	354			RY20 to RY2F
Y1030 to Y103F	163H	355			RY30 to RY3F
Y1040 to Y104F	164H	356			RY40 to RY4F
Y1050 to Y105F	165H	357			RY50 to RY5F
Y1060 to Y106F	166H	358	4	AJ65VBTCU-68DAVN	RY0 to RYF
Y1070 to Y107F	167H	359			RY10 to RY1F
Y1080 to Y108F	168H	360			RY20 to RY2F
Y1090 to Y109F	169H	361			RY30 to RY3F
Y10A0 to Y10AF	16AH	362			RY40 to RY4F
Y10B0 to Y10BF	16BH	363			RY50 to RY5F

The assignment by each signal of the AJ65VBTCU-68ADV and AJ65VBTCU-68DAVN are shown below.

CPU module		Remote station	
Device	Module name	RY	Signal name
Y1000	AJ65VBTCU-68ADV	RY00	Use prohibited
to		to	
Y1017		RY17	
Y1018		RY18	Initial data processing completion flag
Y1019		RY19	Initial data setting request flag
Y101A		RY1A	Error reset request flag
Y101B		RY1B	Use prohibited
to		to	
Y105F		RY5F	
Y1060		AJ65VBTCU-68DAVN	RY00
Y1061	RY01		CH.2 analog output enable/disable flag
Y1062	RY02		CH.3 analog output enable/disable flag
Y1063	RY03		CH.4 analog output enable/disable flag
Y1064	RY04		CH.5 analog output enable/disable flag
Y1065	RY05		CH.6 analog output enable/disable flag
Y1066	RY06		CH.7 analog output enable/disable flag
Y1067	RY07		CH.8 analog output enable/disable flag
Y1068	RY08		Use prohibited
to	to		
Y1077	RY17		
Y1078	RY18		Initial data processing completion flag
Y1079	RY19		Initial data setting request flag
Y107A	RY1A		Error reset request flag
Y107B	RY1B		Use prohibited
to	to		
Y10BF	RY5F		

■RWr assignment

Each number in the figure, No.1 and No.4, represents a station number.

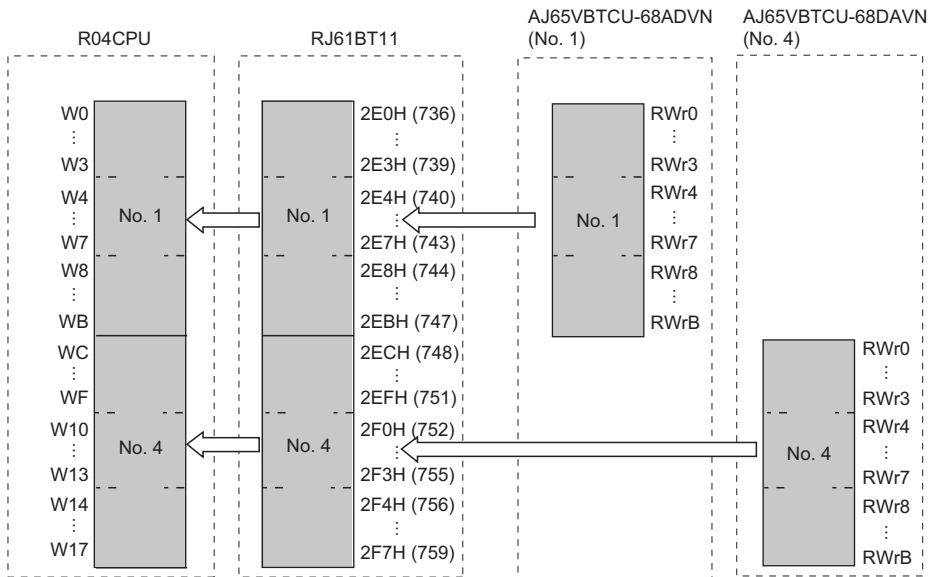

R04CPU	RJ61BT11		Slave station		
	Buffer memory address		Station No.	Module name	RWr
	Hexadecimal	Decimal			
W0	2E0H	736	1	AJ65VBTCU-68ADVN	RWr0
W1	2E1H	737			RWr1
W2	2E2H	738			RWr2
W3	2E3H	739			RWr3
W4	2E4H	740			RWr4
W5	2E5H	741			RWr5
W6	2E6H	742			RWr6
W7	2E7H	743			RWr7
W8	2E8H	744			RWr8
W9	2E9H	745			RWr9
WA	2EAH	746		RWrA	
WB	2EBH	747		RWrB	
WC	2ECH	748	4	AJ65VBTCU-68DAVN	RWr0
WD	2EDH	749			RWr1
WE	2EEH	750			RWr2
WF	2EFH	751			RWr3
W10	2F0H	752			RWr4
W11	2F1H	753			RWr5
W12	2F2H	754			RWr6
W13	2F3H	755			RWr7
W14	2F4H	756			RWr8
W15	2F5H	757	RWr9		
W16	2F6H	758		RWrA	
W17	2F7H	759		RWrB	

The assignment by each signal of the AJ65VBTCU-68ADV and AJ65VBTCU-68DAVN are shown below.

CPU module	Remote station		
Device	Module name	RWr	Signal name
W0	AJ65VBTCU-68ADV	RWr0	CH.1 digital output value
W1		RWr1	CH.2 digital output value
W2		RWr2	CH.3 digital output value
W3		RWr3	CH.4 digital output value
W4		RWr4	CH.5 digital output value
W5		RWr5	CH.6 digital output value
W6		RWr6	CH.7 digital output value
W7		RWr7	CH.8 digital output value
W8		RWr8	Error code
W9		RWr9	Use prohibited
to		to	
WB	RWrB		
WC	AJ65VBTCU-68DAVN	RWr0	CH.1 check code
WD		RWr1	CH.2 check code
WE		RWr2	CH.3 check code
WF		RWr3	CH.4 check code
W10		RWr4	CH.5 check code
W11		RWr5	CH.6 check code
W12		RWr6	CH.7 check code
W13		RWr7	CH.8 check code
W14		RWr8	Error code
W15		RWr9	Use prohibited
to		to	
W17	RWrB		

■RWw assignment

Each number in the figure, No.1 and No.4, represents a station number.

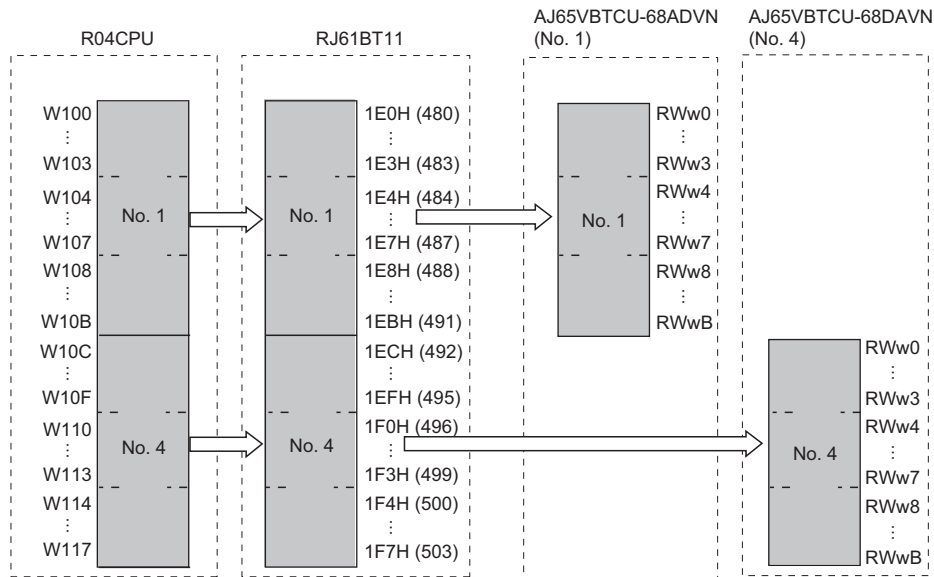

R04CPU	RJ61BT11		Slave station		
	Buffer memory address		Station No.	Module name	RWw
	Hexadecimal	Decimal			
W100	1E0H	480	1	AJ65VBTCU-68ADVN	RWw0
W101	1E1H	481			RWw1
W102	1E2H	482			RWw2
W103	1E3H	483			RWw3
W104	1E4H	484			RWw4
W105	1E5H	485			RWw5
W106	1E6H	486			RWw6
W107	1E7H	487			RWw7
W108	1E8H	488			RWw8
W109	1E9H	489			RWw9
W10A	1EAH	490		RWwA	
W10B	1EBH	491		RWwB	
W10C	1ECH	492	4	AJ65VBTCU-68DAVN	RWw0
W10D	1EDH	493			RWw1
W10E	1EEH	494			RWw2
W10F	1EFH	495			RWw3
W110	1F0H	496			RWw4
W111	1F1H	497			RWw5
W112	1F2H	498			RWw6
W113	1F3H	499			RWw7
W114	1F4H	500			RWw8
W115	1F5H	501			RWw9
W116	1F6H	502		RWwA	
W117	1F7H	503		RWwB	

The assignment by each signal of the AJ65VBTCU-68ADVN and AJ65VBTCU-68DAVN are shown below.

CPU module	Remote station		
Device	Module name	RWw	Signal name
W100	AJ65VBTCU-68ADVN	RWw0	A/D conversion enable/prohibit specification
W101		RWw1	CH.1 to 4 input range setting
W102		RWw2	CH.5 to 8 input range setting
W103		RWw3	Average processing specification
W104		RWw4	CH.1 average time, number of times setting
W105		RWw5	CH.2 average time, number of times setting
W106		RWw6	CH.3 average time, number of times setting
W107		RWw7	CH.4 average time, number of times setting
W108		RWw8	CH.5 average time, number of times setting
W109		RWw9	CH.6 average time, number of times setting
W10A		RWwA	CH.7 average time, number of times setting
W10B		RWwB	CH.8 average time, number of times setting
W10C		AJ65VBTCU-68DAVN	RWw0
W10D	RWw1		CH.2 digital value setting
W10E	RWw2		CH.3 digital value setting
W10F	RWw3		CH.4 digital value setting
W110	RWw4		CH.5 digital value setting
W111	RWw5		CH.6 digital value setting
W112	RWw6		CH.7 digital value setting
W113	RWw7		CH.8 digital value setting
W114	RWw8		Analog output enable/disable setting
W115	RWw9		CH.1 to 4 output range setting
W116	RWwA		CH.5 to 8 output range setting
W117	RWwB		HOLD/CLEAR setting

Settings for a master station

Connect the engineering tool to the CPU module of the master station and set parameters.

1. Set the CPU module as follows.

[Project] ⇒ [New]

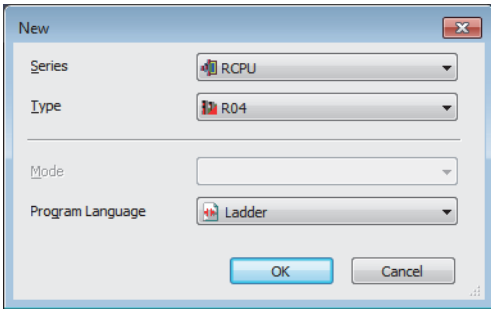

2. Click the [OK] button to add the module labels of the CPU module.

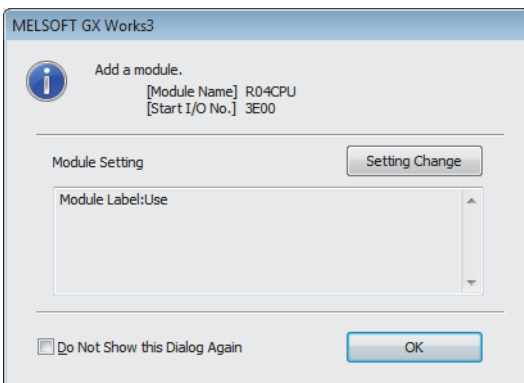

3. Set the master/local module as follows.

[Navigation window] ⇒ [Parameter] ⇒ [Module Information] ⇒ Right-click ⇒ [Add New Module]

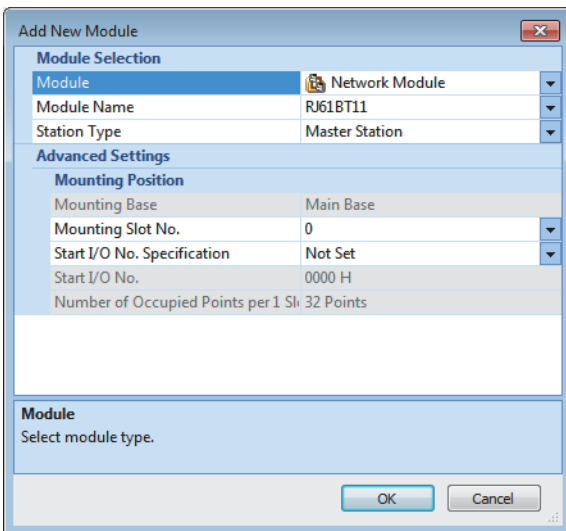

4. Click the [OK] button to add the module labels of the master/local module.

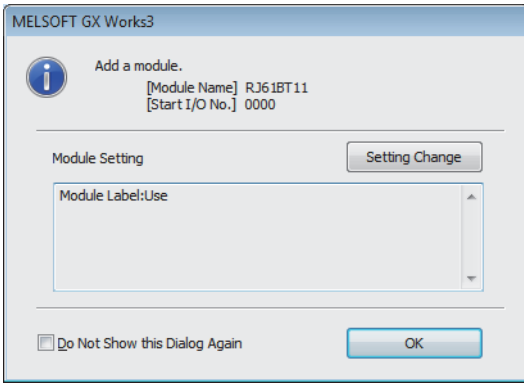

5. Set the items in "Required Settings" as follows.

[Navigation window] ⇒ [Parameter] ⇒ [Module Information] ⇒ [RJ61BT11] ⇒ [Required Settings]

Item	Setting
Station Type	
Station Type	Master Station
Mode	
Communication Mode	Remote Net Ver.1 Mode
Station Number	
Station No.	0
Transmission Speed	
Transmission Speed	156kbps
Parameter Setting Method	
Setting Method of Basic/Application Settings	Parameter Editor

6. Set the network configuration as follows.

[Navigation window] ⇒ [Parameter] ⇒ [Module Information] ⇒ [RJ61BT11] ⇒ [Basic Settings] ⇒ [Network Configuration Settings]

Station No.	Model Name	Station Type	Version	# of STA Occupied	Expanded Cyclic Setting	Remote Station Points	Reserved/Err Invalid STA	Intelligent Buffer Selection(word)			Station-specific mode setting
								Send	Receive	Auto	
0/0	Host Station	Master Station									
1/1	AJ65VBTCLU-68ADVN	Remote Device Station	Ver.1	3 Occupied Sta	Single	96 Points	No Setting				
2/4	AJ65VBTCLU-68DAVN	Remote Device Station	Ver.1	3 Occupied Sta	Single	96 Points	No Setting				

The network diagram below the table shows a bus structure with a Master Station (STA#0) and Remote Device Stations (STA#1-3 and STA#4-6). The diagram includes a legend for STA#0 and a status box indicating 'Total STA#:6'.

7. Set the link refresh settings as follows.

[Navigation window] ⇒ [Parameter] ⇒ [Module Information] ⇒ [RJ61BT11] ⇒ [Basic Settings] ⇒ [Link Refresh Settings]

No.	Link Side					CPU Side				
	Device Name	Points	Start	End		Target	Device Name	Points	Start	End
-	SB	512	00000	001FF	↔	Module Label				
-	SW	512	00000	001FF	↔	Module Label				
1	RX	192	00000	000BF	↔	Device	X	192	01000	010BF
2	RY	192	00000	000BF	↔	Device	Y	192	01000	010BF
3	RWr	24	00000	00017	↔	Device	W	24	00000	00017
4	RWw	24	00000	00017	↔	Device	W	24	00100	00117
5					↔					

8. Set the supplementary cyclic settings as follows.

[Navigation window] ⇒ [Parameter] ⇒ [Module Information] ⇒ [RJ61BT11] ⇒ [Application Settings] ⇒ [Supplementary Cyclic Settings]

Setting Item	Item	Setting
	Supplementary Cyclic Settings	
	Input Data from Data Link Faulty Station	Clear
	Output Mode upon CPU STOP	Send Remote Output (RY)
	Station-based Block Data Assurance	Enable
	Number of Retries	3 Time
	Automatic Reconnection Station Count	1
	Data Link Setting when CPU is Down	Stop the Data Link
	Scan Mode Setting	Asynchronous with Sequence Scan
	Output Mode upon CPU Error	Clear
	Interrupt Settings	
	Interrupt Settings	<Detailed Setting>
	Parameter Name	
	Parameter Name	

9. Set the target station number of the remote device initial setting as follows.

[Navigation window] ⇒ [Parameter] ⇒ [Module Information] ⇒ [RJ61BT11] ⇒ [Basic Settings] ⇒ [Initial Settings]

	Target Station No.	Registered Procedure Information
1	1	No. of Registered Procedures: 0
2	4	No. of Registered Procedures: 0
3		
4		
5		
6		
7		
8		
9		
10		

Buttons: Check, Clear, OK, Cancel

10. Double-click "No. of Registered Procedures" to open the "Remote Device Initial Setting Procedure Registration" window.

11. In "Remote Device Initial Setting Procedure Registration" window, right-click the icon and click "Hexadecimal" of the "Input Format". Set the items in the initial settings as follows.

- Initial setting for an AJ65VBTCU-68ADVN (station No.1)

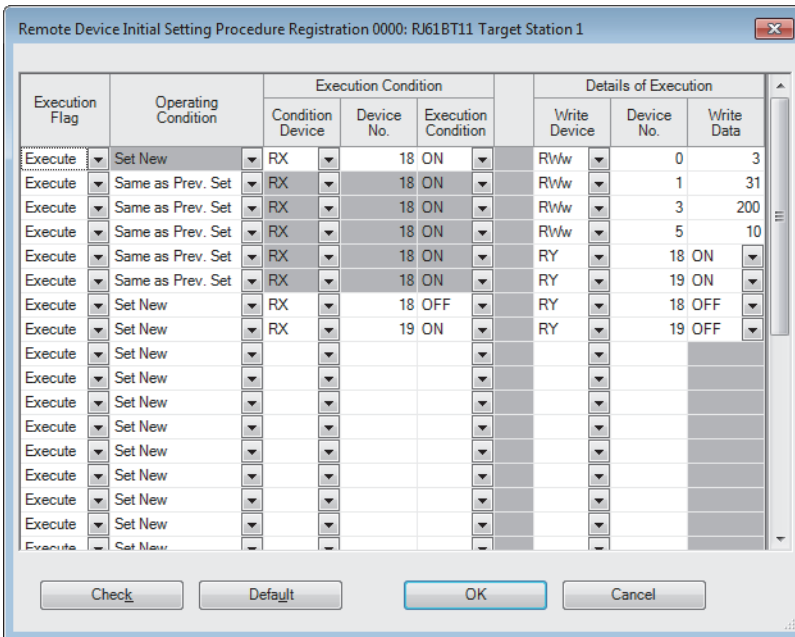

Setting the initial setting executes the following processing from the first condition.

Condition	Description
1st	The CH.1 and CH.2 are set to the A/D conversion enable.
2nd	An input range is set. <ul style="list-style-type: none"> • CH.1: 0 to 5V • CH.2: User range setting 1 (-10 to 10V)
3rd	Whether a averaging processing or averaging process is executed is set. <ul style="list-style-type: none"> • CH.1: Sampling processing • CH.2: Averaging processing (count average)
4th	The average count of the CH.2 is set to 16.
5th	Initial data processing completion flag is turned on.
6th	Initial data setting request flag is turned on.
7th	Initial data processing completion flag is turned off.
8th	Initial data setting request flag is turned off.

- Initial setting for an AJ65VBTCU-68DAVN (station No.4)

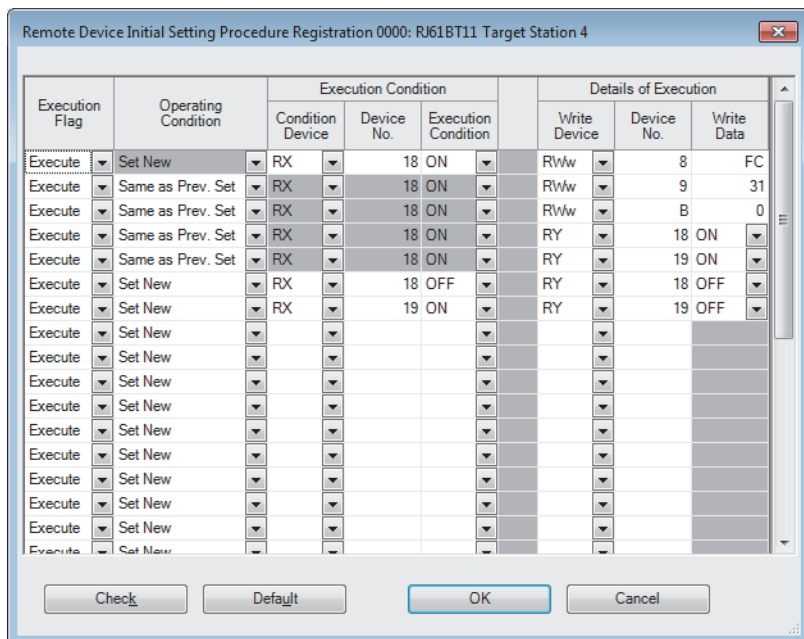

Setting the initial setting executes the following processing from the first condition.

Condition	Description
1st	The CH.1 and CH.2 are set to the analog output enable.
2nd	An output range is set. <ul style="list-style-type: none"> • CH.1: 0 to 5V • CH.2: User range setting 1 (-10 to 10V)
3rd	The HOLD/CLEAR setting is configured. <ul style="list-style-type: none"> • CH.1: CLEAR • CH.2: CLEAR
4th	Initial data processing completion flag is turned on.
5th	Initial data setting request flag is turned on.
6th	Initial data processing completion flag is turned off.
7th	Initial data setting request flag is turned off.

12. Write the set parameters to the CPU module on the master station. Then reset the CPU module or power off and on the system.

[Online] ⇄ [Write to PLC]

Point

In this example, default values were used for parameters that are not shown above. For the parameters, refer to the following.

MELSEC iQ-R CC-Link System Master/Local Module User's Manual (Application)

Settings for a remote device station

Set the station number, transmission speed, and mode using the switches on the remote device station.

Switch setting on an AJ65VBTCU-68ADV

- Station number setting switch, transmission speed setting switch: Only the station No.4 turns on. (station No.1, 156kbps)
- Mode selection switch: 0 (normal mode)

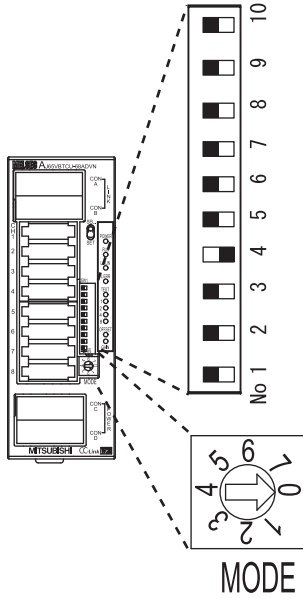

Switch setting on an AJ65VBTCU-68DAVN

- Station number setting switch, transmission speed setting switch: Only the station No.6 turns on. (station No.4, 156kbps)
- Mode selection switch: 0 (normal mode)

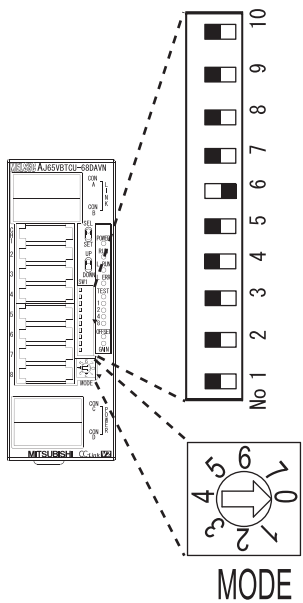

Checking the data link status

Check whether the master station and remote device station are normally operating data link.

1. Power on the remote station, then master station to start data link.
2. When the LEDs are in the following states, data link is being performed normally.

- LEDs on the master station

LED	Status
RUN	On
ERR.	Off
MST	On
S MST	Off
156K	On
625K	Off
2.5M	
5M	
10M	
L RUN	
L ERR.	Off
SD	Flashing ^{*1}
RD	

*1 The LEDs may look dimly lit or off depending on the communication status.

- LEDs on the AJ65VBTCU-68ADV and AJ65VBTCU-68DAVN

LED	Status
POWER	On
RUN	On
L RUN	On
L ERR	Off
TEST	Off

Program example

- Master station (station No.0)

Classification	Label name	Description	Device
Module label	BT11_1.bIn_ModuleFailure	Module failure	X0
	BT11_1.bIn_DataLink	Own station data link status	X1
	BT11_1.bIn_ModuleReady	Module ready	XF
	BT11_1.bReq_RemoteDeviceStationInitialization	Remote device station initialization procedure registration instruction	SB000D
	BT11_1.bCompl_RemoteDeviceStationInitialization	Completion status of remote device station initialization procedure	SB005F
	BT11_1.bnSts_DataLinkError_Other[1]	Data link status of other stations (station No.1)	SW0080.0
	BT11_1.bnSts_DataLinkError_Other[4]	Data link status of other stations (station No.4)	SW0080.3

Label to be defined Define global labels as shown below:

Label Name	Data Type	Class	Assign (Device/Label)
StartDirection	Bit	VAR_GLOBAL	M100
Initialization_68ADVN	Bit	VAR_GLOBAL	X20
Initialization_68DAVN	Bit	VAR_GLOBAL	X21
DigitalValue_68ADVN	Bit	VAR_GLOBAL	X22
EnableAnalogOutput_68ADVN	Bit	VAR_GLOBAL	X23
ResetError_68ADVN	Bit	VAR_GLOBAL	X25
ResetError_68DAVN	Bit	VAR_GLOBAL	X26
DataLinkError_68ADVN	Bit	VAR_GLOBAL	Y30
DataLinkError_68DAVN	Bit	VAR_GLOBAL	Y31
DigitalOutputValue_CH1_68ADVN	Word [Unsigned]/Bit String [16-bit]	VAR_GLOBAL	D500
DigitalOutputValue_CH2_68ADVN	Word [Unsigned]/Bit String [16-bit]	VAR_GLOBAL	D501
ErrorCode_68ADVN	Word [Unsigned]/Bit String [16-bit]	VAR_GLOBAL	D508
CheckCode_CH1_68ADVN	Word [Unsigned]/Bit String [16-bit]	VAR_GLOBAL	D510
CheckCode_CH2_68ADVN	Word [Unsigned]/Bit String [16-bit]	VAR_GLOBAL	D511
ErrorCode_68DAVN	Word [Unsigned]/Bit String [16-bit]	VAR_GLOBAL	D518

Device	Description	Module
X1000 to X105F	Remote input (RX0 to RX5F)	AJ65VBTCU-68ADVN
Y1000 to Y105F	Remote output (RY0 to RY5F)	
W0 to WB	Remote register (RWr0 to RWrB)	
W100 to W10B	Remote register (RWw0 to RWwB)	
X1060 to X10BF	Remote input (RX0 to RX5F)	AJ65VBTCU-68DAVN
Y1060 to Y10BF	Remote output (RY0 to RY5F)	
WC to W17	Remote register (RWr0 to RWrB)	
W10C to W117	Remote register (RWw0 to RWwB)	

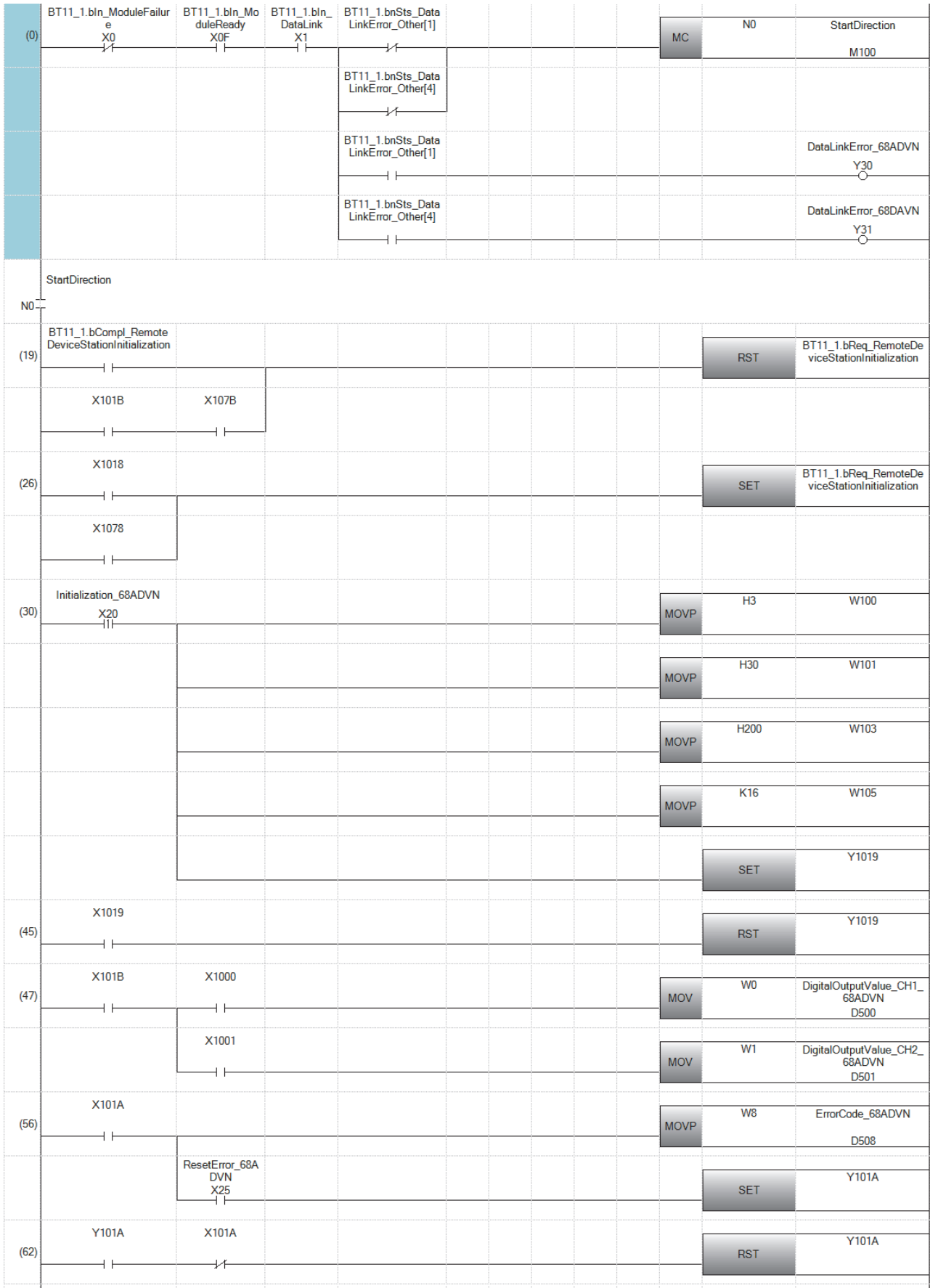

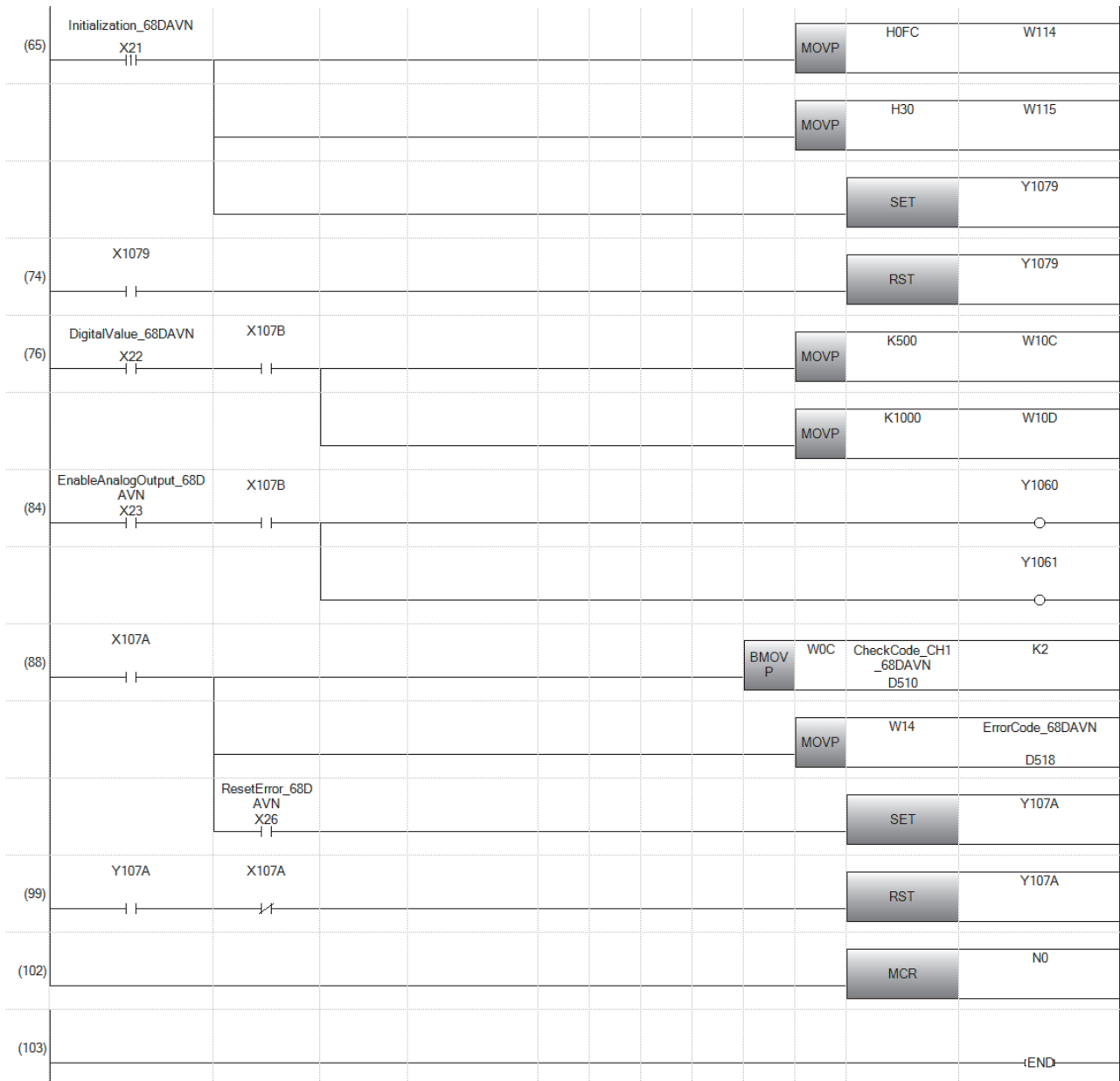

(0) The data link status is checked.

(26)When 'Remote device station initialization procedure registration instruction' (SB000D) is turned on, the initial setting is executed. When the initial setting is completed, the input value of the AJ65VBTCU-68ADV is converted into a digital value.

(30)When 'Initialization_68ADV' (X20) is turned on, the initial setting of the AJ65VBTCU-68ADV is changed.

(47)The CH.1 digital output value is stored in 'DigitalOutputValue_CH1_68ADV' (D500) and CH.2 digital output value is stored in 'DigitalOutputValue_CH2_68ADV' (D501).

(56)If an error occurs in the AJ65VBTCU-68ADV, an error code is stored in 'ErrorCode_68ADV' (D508). After the cause of the error is eliminated and 'ResetError_68ADV' (X25) is turned on, the error is reset.

(65)When 'Initialization_68ADV' (X21) is turned on, the initial setting of the AJ65VBTCU-68ADV is changed.

(76)When 'DigitalValue_68ADV' (X22) is turned on, the digital value of the AJ65VBTCU-68ADV is set.

(84)When 'EnableAnalogOutput_68ADV' (X23) is turned on, the analog value is output from the AJ65VBTCU-68ADV.

(88)If an error occurs in the AJ65VBTCU-68ADV, an error code is stored in 'ErrorCode_68ADV' (D518). After the cause of the error is eliminated and 'ResetError_68ADV' (X26) is turned on, the error is reset.

Point

- When creating the programs of (19) to (26), refer to the manual for the remote device station used and change the program as needed.
- The programs of (30) to (45) and (65) to (74) are needed only for the initial setting change.

APPENDIX

Appendix 1 External Dimensions

The following figure shows the external dimensions of the master/local module.

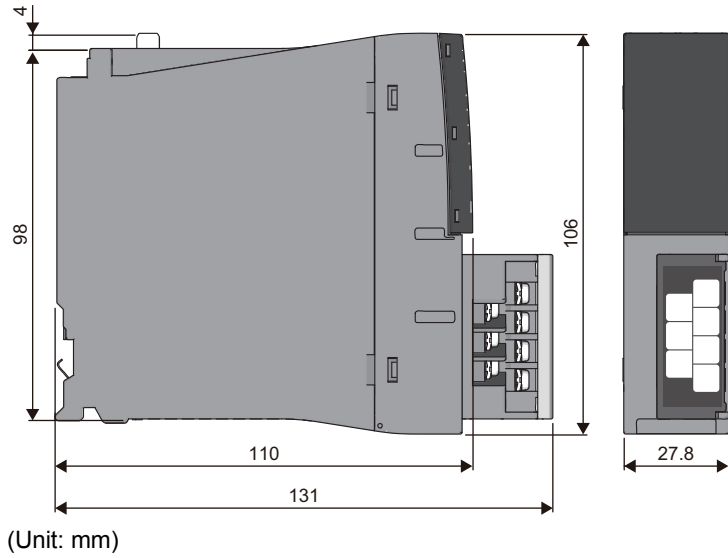

A

INDEX

C

Connection cable	17
Cyclic transmission	13

D

Dot matrix LED	16
--------------------------	----

I

Internal current consumption	17
--	----

L

Local station	13
-------------------------	----

M

Master station	13
Master/local module	13
Maximum number of link points	17
Maximum overall cable length	17
Maximum transmission distance	17

N

Number of link points by the number of occupied stations	18
--	----

R

Redundant system	13
Remote device net Ver.1 mode	13,23
Remote device net Ver.2 mode	13,23
Remote device station	13
Remote I/O net mode	14,23
Remote I/O station	14
Remote net Ver.1 mode	14,23
Remote net Ver.2 mode	14,23
Remote station	14

S

Solderless terminal	32
Standby system	14
System switching	14

T

Terminal block	32
Terminal block mounting screw	32
Terminal block screw	32
Terminating resistor	34
Tightening torque	32
Transient transmission	14
Transmission speed	17

W

Weight	17
------------------	----

MEMO

REVISIONS

*The manual number is given on the bottom left of the back cover.

Revision date	*Manual number	Description
June 2014	SH(NA)-081269ENG-A	First edition
May 2016	SH(NA)-081269ENG-B	■Added or modified parts RELEVANT MANUALS, Section 5.1, 7.1
April 2018	SH(NA)-081269ENG-C	■Added functions Automatic detection of connected device, iQ Sensor Solution data backup/restoration function ■Added or modified parts SAFETY PRECAUTIONS, RELEVANT MANUALS, Chapter 3, Section 7.1

Japanese manual number: SH-081267-C

This manual confers no industrial property rights of any other kind, nor does it confer any patent licenses. Mitsubishi Electric Corporation cannot be held responsible for any problems involving industrial property rights which may occur as a result of using the contents noted in this manual.

© 2014 MITSUBISHI ELECTRIC CORPORATION

WARRANTY

Please confirm the following product warranty details before using this product.

1. Gratis Warranty Term and Gratis Warranty Range

If any faults or defects (hereinafter "Failure") found to be the responsibility of Mitsubishi occurs during use of the product within the gratis warranty term, the product shall be repaired at no cost via the sales representative or Mitsubishi Service Company.

However, if repairs are required onsite at domestic or overseas location, expenses to send an engineer will be solely at the customer's discretion. Mitsubishi shall not be held responsible for any re-commissioning, maintenance, or testing on-site that involves replacement of the failed module.

[Gratis Warranty Term]

The gratis warranty term of the product shall be for one year after the date of purchase or delivery to a designated place. Note that after manufacture and shipment from Mitsubishi, the maximum distribution period shall be six (6) months, and the longest gratis warranty term after manufacturing shall be eighteen (18) months. The gratis warranty term of repair parts shall not exceed the gratis warranty term before repairs.

[Gratis Warranty Range]

- (1) The range shall be limited to normal use within the usage state, usage methods and usage environment, etc., which follow the conditions and precautions, etc., given in the instruction manual, user's manual and caution labels on the product.
- (2) Even within the gratis warranty term, repairs shall be charged for in the following cases.
 1. Failure occurring from inappropriate storage or handling, carelessness or negligence by the user. Failure caused by the user's hardware or software design.
 2. Failure caused by unapproved modifications, etc., to the product by the user.
 3. When the Mitsubishi product is assembled into a user's device, Failure that could have been avoided if functions or structures, judged as necessary in the legal safety measures the user's device is subject to or as necessary by industry standards, had been provided.
 4. Failure that could have been avoided if consumable parts (battery, backlight, fuse, etc.) designated in the instruction manual had been correctly serviced or replaced.
 5. Failure caused by external irresistible forces such as fires or abnormal voltages, and Failure caused by force majeure such as earthquakes, lightning, wind and water damage.
 6. Failure caused by reasons unpredictable by scientific technology standards at time of shipment from Mitsubishi.
 7. Any other failure found not to be the responsibility of Mitsubishi or that admitted not to be so by the user.

2. Onerous repair term after discontinuation of production

- (1) Mitsubishi shall accept onerous product repairs for seven (7) years after production of the product is discontinued. Discontinuation of production shall be notified with Mitsubishi Technical Bulletins, etc.
- (2) Product supply (including repair parts) is not available after production is discontinued.

3. Overseas service

Overseas, repairs shall be accepted by Mitsubishi's local overseas FA Center. Note that the repair conditions at each FA Center may differ.

4. Exclusion of loss in opportunity and secondary loss from warranty liability

Regardless of the gratis warranty term, Mitsubishi shall not be liable for compensation to:

- (1) Damages caused by any cause found not to be the responsibility of Mitsubishi.
- (2) Loss in opportunity, lost profits incurred to the user by Failures of Mitsubishi products.
- (3) Special damages and secondary damages whether foreseeable or not, compensation for accidents, and compensation for damages to products other than Mitsubishi products.
- (4) Replacement by the user, maintenance of on-site equipment, start-up test run and other tasks.

5. Changes in product specifications

The specifications given in the catalogs, manuals or technical documents are subject to change without prior notice.

TRADEMARKS

Ethernet is a registered trademark of Fuji Xerox Co., Ltd. in Japan.

The company names, system names and product names mentioned in this manual are either registered trademarks or trademarks of their respective companies.

In some cases, trademark symbols such as [™] or [®] are not specified in this manual.

SH(NA)-081269ENG-C(1804)MEE

MODEL: RJ61BT11-U-IN-E

MODEL CODE: 13JX10

mitsubishi electric corporation

HEAD OFFICE : TOKYO BUILDING, 2-7-3 MARUNOUCHI, CHIYODA-KU, TOKYO 100-8310, JAPAN
NAGOYA WORKS : 1-14, YADA-MINAMI 5-CHOME, HIGASHI-KU, NAGOYA, JAPAN

When exported from Japan, this manual does not require application to the
Ministry of Economy, Trade and Industry for service transaction permission.

Specifications subject to change without notice.